

Cabling Infrastructure Design Specification for New Buildings

Final Version 2.2



1 Specification for the Design of Cabling Infrastructures in University Environments

Document Reference: CommScope 2

Issue	2.2
Date	02 September 2019
Author	Karl Tryner
Copyright	Ethicus Consultancy Ltd

Intellectual Property Statement
Ethicus Consultancy Ltd Copyright

Document Control

Revision Control

All documentation will be updated at the discretion of the University of Southampton. Any changes to the documentation will require a new issue to be produced and re-circulated to all parties.

Changes deemed by the University of Southampton as minor will be issued as addendum's to this tender document and will be reflected accordingly in the revision control section. Changes deemed by the University of Southampton as major will be revised as a new issue of the tender document and will be reflected accordingly in the revision control section.

Issue	Date	Reason	Implemented by
1.0	24/05/18	Issued	K.Tryner
2.0	26/07/19	<ol style="list-style-type: none"> 1. Copper patch cable labels the same colour 2. All single cabinets have two off 10" and all multiple have 4" at both ends and 16" in between racks 3. Changed to open frames 4. Wall mount cabinet options added 5. One aircon on to UPS in each room 6. Fibre moved to top of frame 7. Fibre patch panels change to split metal panels 8. Active cabinet on the right and passive on the left 9. Section added on commissioning life net and pdu's 10. PoE section added 11. Ceilings in telecom rooms removed 12. Horizontal cable managers removed from frames 13. Maximum of nine switches in a single stack 18U so that second stack can commence 14. Locking PDU mains patch cables to be used for rack pdu to switches 15. All basket containment in hub rooms updated to 600mm x 50/60mm 16. EZ devices added to telecom room cable entry points 17. Each rack has its own secondary earth bonding to the earth bar 18. Double cat 6a outlet removed from telecom rooms 19. Updated parts list for frames 20. DCIM for hub rooms updated 	K.Tryner

		<ol style="list-style-type: none"> 21. CCTV signage added to telecom rooms 22. Normally replaced with shall be 23. Section on rack consolidation added 24. Refurbishment floor in an existing building shall be in consultation with iSolutions for guidance on category standard and potential rack consolidation requirements added 25. Only floor boxes deployed must have a minimum of 50mm below the face plate and have its own section of compartment to central containment 26. 32mm kopex can only carry 4 cat 6a added 27. Do not use 25mm Kopex added 28. Removed figure 55 - consolidation panels in ceilings 29. Dado trunking – consideration for sizing due to cat 6a oversized type to allow more cabling to be run in dado- 30. Lockable devices for wireless access points removed 31. 5m lazy loops for WAP removed 32. No inverted basket permitted 33. Any remote site that connects on EVC over fibre due to distance should have a UPS at each end 34. Designs for structured cabling SHALL be completed by a RCCD qualified designer and in strict compliance with UOS specifications 35. Products updated 36. All cat 6a FFTP to be white 37. Remove plastic fibre patch panels from component specification 38. Mighty Mo 10 changed to 20 39. Updated copper patch diagrams to reflect new patching regime 40. New accommodation blocks should be Bca class 41. Patching schedule added 42. Add external wifi provision in isolutions wifi specification . Ducting updated and added as an appendix 	
		<ol style="list-style-type: none"> 1. Cabinet labelling added F and R 2. Bonding of cables for voice 3. Earth module 237 type for voice 4. Tying of cable restraints on voice 5. Floor pedestals to not interfere with apertures 	

		<ol style="list-style-type: none"> 6. Power lead section adding for dressing cables 7. A/C to change to N only 8. Frames from black to white 9. Commandos can be fitted underfloor 10. Removed waterfalls for underfloor 11. Added bonding size for floor 12. Added section of how to measure lighting with a grid and front view of cabinets 13. Labelling for earth bonds 14. Bonding of suspended floor added 15. Cabinet earth label 16. EVC cable label 17. Voice cable restraint 18. Voice box label 19. FireTuf cable label 20. Temperature controller added 21. Lighting measurement section added 22. TREND sensor and 2 off Rittal sensors amended 23. FireTuf – earth bonding 24. Fire brushes added to cut apertures in MER and SER rooms 25. Added a contractors link in horizontal designs 	
2.2	02/09/19	<ol style="list-style-type: none"> 1. BS 7671 updated to 18th edition 2. Attenuation criteria for mated plugs and cables added to fibre testing 	K.Tryner

Table of Contents

Contents

1	INTRODUCTION	13
1.1	OVERVIEW	13
1.2	SPECIFICATION OF CRITERIA	13
2	DEFINITION OF TERMS	14
2.1	DEFINITION OF TERMS	14
2.1.1	<i>Buildings</i>	14
2.1.2	<i>Backbone cable</i>	14
2.1.3	<i>Channel</i>	14
2.1.4	<i>Consolidation point</i>	14
2.1.5	<i>CP link</i>	14
2.1.6	<i>Cross connect</i>	14
2.1.7	<i>Distribution Equipment Room (DER)</i>	14
2.1.8	<i>Entrance room</i>	14
2.1.9	<i>Pit</i>	14
2.1.10	<i>Pit cover</i>	14
2.1.11	<i>Main Equipment Room (MER)</i>	14
2.1.12	<i>Satellite Equipment Room (SER)</i>	15
2.1.13	<i>Solution</i>	15
2.1.14	<i>Telecommunications</i>	15
2.1.15	<i>Telecoms room</i>	15
2.2	ABBREVIATIONS	16
3	CABLING SYSTEMS	17
3.1	OVERVIEW	17
3.2	CABLING SYSTEM STRUCTURE	17
3.2.1	<i>Campus backbone cabling subsystem</i>	17
3.2.2	<i>Building backbone cabling subsystem</i>	18
3.2.3	<i>Horizontal cabling subsystem</i>	18
4	TELECOMMUNICATIONS ROOM	19
4.1	OVERVIEW	19
4.2	POSITION	19
4.2.1	<i>General</i>	19
4.2.1.1	<i>Multiple MER Data Room Design for New Buildings</i>	19
4.2.1.2	<i>Multiple Floor Data Room Design for New Buildings</i>	20
4.2.2	<i>Siting Telecom Rooms</i>	22
4.3	SIZE OF TELECOM ROOM	22
4.3.1	<i>General</i>	22
4.4	TELECOM ROOM LAYOUT	24
4.4.1	<i>MER B and all SERs</i>	24
4.4.2	<i>MER A</i>	24
4.5	OPEN SPACE LAYOUTS	24
4.5.1	<i>Single Rooms</i>	25
4.5.2	<i>Corridors and Throughways</i>	25
4.5.3	<i>Cabinet Sizing</i>	26
4.6	DOOR ENTRY	27
4.7	CABINET ELEVATIONS	28

4.7.1	SER Cabinet Layout	28
4.7.2	MER B Cabinet Layout	29
4.7.3	MER A Cabinet Layout	30
4.8	LIGHTING	30
4.8.1	Lighting Design	30
4.8.2	Lighting Measurements	31
4.9	COOLING	33
4.8.1	Telecom Room Requirements	33
4.8.2	Free Cooling Room Layouts.....	35
4.8.3	DX Cooling Room Layouts.....	36
4.10	POWER.....	38
4.11	UPS.....	40
4.11.1	N Redundancy.....	40
4.12	POWER OVER ETHERNET (PoE)	42
4.13	ENVIRONMENTAL MONITORING	42
4.14	INTERNAL CABLE TRAY.....	42
4.14.1	Telecom Room High Level Containment.....	42
4.14.2	Telecom Room Low Level Containment.....	43
4.15	FLOOR FINISH	45
4.15.1	Suspended Floor.....	45
4.15.9	Solid Floor	45
4.16	ACOUSTIC PERFORMANCE	45
4.17	CABLE PENETRATION	45
4.18	EARTH BONDING	46
4.18.1	MER and SER Main Bonding	46
4.18.2	Cabinet Grounding Bar	48
4.18.3	Earth Grounding Cables for Cabinets.....	49
4.18.4	Earth Grounding Cables for Suspended Floor	50
4.18.5	Earth Grounding Cables for Patch Panels and Doors.....	50
4.18.6	Earth Grounding Cables for PDUs.....	51
4.19	SECURITY	52
4.20	FIRE DETECTION	52
4.21	PRE-COMMISSIONING PATCH PANEL PROTECTION	52
4.22	TELECOM ROOM CLEANING.....	52
4.23	FRAMES.....	52
4.23.1	Frame Configuration for a MER B and SERs (2 Frames).....	52
4.23.1.1	Sole occupancy telecom room for iSolutions	52
4.23.1.2	Shared occupancy telecom room.....	53
4.23.2	Frame Configuration for a MER A (5 Frames).....	53
4.23.2.1	Sole occupancy telecom room for iSolutions	53
4.23.2.2	Shared occupancy telecom room for iSolutions.....	53
5	HORIZONTAL DISTRIBUTION.....	54
5.1	OVERVIEW	54
5.2	CHANNEL DESIGN RULES.....	54
5.3	MEDIA SELECTION	55
5.4	PATCH CORD COLOURS AND CATEGORY	55
5.5	VELCRO STRAPS.....	55
5.6	USE CASE OUTLET QUANTITIES	56
5.7	OUTLET PRESENTATION	57
5.7.1	Floor Boxes.....	57
5.7.2	Contractors Link.....	58
5.7.3	Under Floor Minipod.....	59
5.7.4	Power pole	60
5.7.5	Dado trunking.....	61
5.7.6	Stud walls.....	62
5.7.7	Dry Riser.....	64

5.7.8	<i>Suspended Ceiling</i>	66
5.7.9	<i>Ceiling Mounted – No Suspended Ceiling</i>	67
5.7.10	<i>Surface Mounted</i>	68
5.7.11	<i>Temporary Outlets</i>	70
5.7.12	<i>External</i>	71
5.7.13	<i>External APs</i>	72
5.7.14	<i>Remote external APs with Powered Fibre Cable</i>	72
5.8	BARRIER SYSTEMS FOR VEHICLES	75
5.9	CABLE MANAGEMENT	75
5.9.1	<i>Trunking Loose Laid</i>	75
5.9.2	<i>Cable Basket</i>	76
5.10	CABLE CAPACITY	77
5.11	HORIZONTAL CABLE BASKET AND TRUNKING	77
5.11.1	<i>General Rules for Containment</i>	77
5.11.2	<i>Suspended Floor Containment</i>	83
5.11.3	<i>Suspended Ceiling Containment</i>	84
5.12	TRUNKING	87
5.13	SCREED TRUNKING	88
5.14	RESILIENCE	89
5.14.1	<i>336 Channels – Level 1</i>	89
5.14.2	<i>672 Channels - Level 2</i>	89
5.15	COPPER TESTING	90
6	BACKBONE DISTRIBUTION	91
6.1	OVERVIEW	91
6.2	MEDIA CHOICE	91
6.2.1	<i>OS2 / Blown Fibre</i>	91
6.3	MER AND BUILDING INCOMING FIBRE DESIGN	92
6.4	FIBRE POLARITY	94
6.5	FIBRE JOINT ARRANGEMENTS	94
6.5.1	<i>Dual Joint Arrangement</i>	94
6.5.2	<i>Single Joint Arrangement</i>	95
6.6	FIBRE BACKBONE TESTING	97
6.6.1	<i>Witness Tests</i>	97
6.6.2	<i>Test Records</i>	97
6.6.3	<i>Test Equipment</i>	97
7	EMERGENCY VOICE COMMUNICATION (EVC)	98
7.1	OVERVIEW	98
7.2	EXTERNAL/INTERNAL TRUNK CABLE MEDIA SELECTION	99
7.3	INTERNAL HORIZONTAL CABLE MEDIA SELECTION	99
7.4	USE CASE OUTLET QUANTITIES	99
7.5	EMERGENCY VOICE DESIGN	100
7.5.1	<i>University of Southampton Campus Emergency Voice Trunk</i>	101
7.5.2	<i>Refuge and Disabled Toilets – From the University of Southampton DP</i>	103
7.5.3	<i>Fire Alarm, Critical Alarm, Refuge Call Point, Autodialers etc – From the BT demarcation point</i>	104
7.5.4	<i>Lift Telephony – From The University of Southampton DP</i>	104
8	AUDITING	106
8.1	COMMSCOPE AUDIT	106
8.2	ISOLUTIONS AUDIT	106
8.3	IAUDITOR	106
9	ROLES AND RESPONSIBILITIES	107
9.1	GENERAL	107
9.2	RESPONSIBILITIES	107

9.2.1	<i>Building Designer</i>	107
9.2.2	<i>Main Contractor</i>	107
9.2.3	<i>Estates & Facilities</i>	109
9.2.4	<i>iSolutions</i>	110
10	DOCUMENTATION	111
10.1	PROJECT START-UP AND SPECIFICATION	111
10.2	AS BUILT DOCUMENTATION	111
10.2.1	<i>Documentation from Data contractor</i>	111
10.2.2	<i>Documentation from fibre Contractor</i>	112
10.2.3	<i>Documentation from Civil or Buildings contractor</i>	112
10.3	ELECTRONIC RECORDING	112
10.3.1	<i>Major new installations by an externally Appointed Data Contractor</i>	112
11	STANDARDS	114
11.1	STANDARDS	114
11.1.1	<i>British Standards Institute</i>	114
11.1.2	<i>Cenelec</i>	114
11.1.3	<i>IEC</i>	115
11.1.4	<i>Miscellaneous</i>	115
12	COMPONENT SPECIFICATION	117
12.1	GENERAL	117
12.2	COPPER CABLES	117
12.2.1	<i>CommScope– Cat 6a Cca</i>	117
12.2.2	<i>Telecom cables</i>	117
12.3	COPPER JACKS AND PATCH PANELS	118
12.3.1	<i>CommScope– Cat 6a</i>	118
12.4	COPPER PATCH LEADS	120
12.4.1	<i>CommScope– Cat 6a</i>	120
12.5	FIBRE CABLES AND TUBES	121
12.5.1	<i>CommScope– Tight Buffered: recommended for internal applications</i>	121
12.5.2	<i>CommScope– Loose Tube: recommended for external applications</i>	121
12.6	FIBRE CABLES	122
12.6.1	<i>CommScope– Blown Fibre</i>	122
12.6.2	<i>CommScope– Blown Fibre Tube</i>	122
12.7	ACCESSORIES	123
12.7.1	<i>CommScope – Blown Fibre accessories</i>	123
12.8	FIBRE JACKS	125
12.9	FIBRE PATCHCORDS AND PIGTAILS	125
12.10	VOICE BOXES	127
12.11	VOICE 237 MODULES	128
12.12	VOICE 10 PAIR LABEL HOLDERS AND LABELS	129
12.13	LIGHTNING PROTECTION	130
12.14	CONVERTERS	131
12.15	FRAMES/CABINETS	132
12.16	POWERED FIBRE CABLE	132
APPENDIX A	FIBRE INSPECTION AND CLEANING	135
A.1	WARNINGS	135
A.2	INSPECTION	135
A.3	DRY CLEANING WITH CARTRIDGE OR CARD BASED PRODUCTS	135
A.4	DRY CLEANING WITH LINT FREE WIPES	136
A.5	WET CLEANING WITH LINT FREE WIPES	136

A.6	CONTAMINATION EXAMPLES	138
APPENDIX B	PATCHING FOR COPPER AND FIBRE	140
B.1	COPPER PATCH PANEL PATCHING IN SINGLE CABINETS	140
B.2	COPPER PATCH PANEL PATCHING IN MULTIPLE CABINETS	141
B.3	FIBRE SPLIT PATCH PANEL PATCHING	142
B.4	FIBRE PATCH PANEL PATCHING	143
B.5	MAINS LEAD PATCHING	144
B.6	PATCHING SCHEDULE	145
APPENDIX C	LABELLING FOR PATCH PANELS, MINIPODS, OUTLETS, CABLES AND BLOWN FIBRE DUCTING 147	
C.1	TYPE OF LABEL	147
C.2	LABEL COLOUR – HORIZONTAL PATCH PANEL COPPER PORTS	147
C.3	LABEL COLOUR – PATCH PANEL FIBRE PORTS	148
C.4	LABELLING SCHEME – OUTLETS	148
C.5	LABELLING SCHEME – MINIPOD OR FLOOR BOX	148
C.6	LABELLING SCHEME – HORIZONTAL PATCH PANEL	149
C.7	LABELLING SCHEME – BACKBONE FIBRE	150
C.8	LABELLING SCHEME – FIBRE PATCH PANEL	151
C.9	LABELLING SCHEME – CABINET	151
C.10	LABELLING SCHEME – COMMANDO SOCKET	152
C.11	LABELLING SCHEME – PDU	152
C.12	LABELLING SCHEME – HORIZONTAL CABLE	153
C.13	LABELLING SCHEME – COPPER PATCH LEADS	153
C.14	LABELLING SCHEME – BACKBONE FIBRE CABLE	153
C.15	LABELLING SCHEME – FIBRE PATCH LEADS	154
C.16	LABELLING SCHEME – MAINS LEADS	155
C.17	LABELLING SCHEME – EARTH CABLES FOR CABINETS	155
C.18	LABELLING SCHEME – EARTH CABLES FOR SUSPENDED FLOOR	155
C.19	LABELLING SCHEME – EVC TELCO CABLE	156
C.20	LABELLING SCHEME – FIRETUF CABLES	156
C.21	LABELLING SCHEME – EVC DISTRIBUTION FRAME, RACK OR WALL BOX	157
C.22	LABELLING SCHEME – BLOWN FIBRE OVERVIEW	157
C.14A	LABELLING SCHEME – BLOWN FIBRE GAS SEAL	159
C.14B	LABELLING SCHEME – BLOWN FIBRE TDU	160
C.14C	LABELLING SCHEME – CORE BLOWN FIBRE DUCT ROUTE	160
C.14D	LABELLING SCHEME – SPUR BLOWN FIBRE DUCT ROUTE	162
C.14E	LABELLING SCHEME – MER TO SER DUCT ROUTE	162
APPENDIX D	MAIN CONTRACTOR HUB ROOM SIGN OFF CHECKLIST	164

D.1	CHECK LIST.....	164
APPENDIX E	WLAN PREDICTIVE MODELLING PARAMETERS	166
APPENDIX F	- CALL POINT SPECIFICATION	167
APPENDIX G	- MAC ADDRESS INFORMATION.....	168
APPENDIX H	DCIM CONFIGURATION	1
H.1	MER - REQUIREMENTS AND COMMISSIONING OF UPS LIFE NET FOR VERTIV REMOTE MONITORING.....	1
H.2	SUPPLY AND COMMISSION 1U RARITAN PDUS.....	1
H.3	SUPPLY AND COMMISSION 0U RARITAN PDUS.....	2
H.4	MER - REQUIREMENTS AND COMMISSIONING OF ENVIRONMENTAL MONITORING	3
H.5	IEC LEADS	4
H.6	REQUESTING A STATIC IP ADDRESS	6
I.1	TEST REFERENCE CORD (TRC) VERIFICATION –FOR LSPM	7
I.2	REFERENCE SETTING -1 JUMPER METHOD	8
I.3	REFERENCE SETTING -3 JUMPER METHOD	10
I.4	TESTING	11
I.5	TESTING PARAMETERS – 1 JUMPER METHOD.....	11
I.6	TESTING PARAMETERS – 3 JUMPER METHOD.....	12
J.1	DUCTING CAPACITY	14
J.2	SUB DUCT SIZING.....	14
J.3	DUCTING AND SUB DUCTING CONSTRUCTION AND COLOUR	15
J.4	BUILDING ENTRANCE NEW BUILDS	16
J.5	BUILDING ENTRANCE EXISTING BUILDS	16
J.6	BUILDING ENTRANCE BASEMENT FOR NEW BUILDS	17
J.7	BUILDING ENTRANCE BASEMENT FOR EXISTING BUILDS	18
J.8	BUILDING ENTRANCE WHERE ACCESS PITS CAN FLOOD INTO A BUILDING	19
J.9	DUCTING LAYING.....	20
J.10	DUCTING DEPTH	22
J.11	DUCT ROUTE DEVIATION	23
J.12	RODING AND ROPING.....	23
J.13	MARKER TAPE	24
J.14	DUCT SEALS	24
J.15	SUB DUCT	25
J.16	ACCESS PITS.....	26
J.17	ACCESS PIT, DUCT AND SUB DUCT LABELLING	27
J.18	DUCT TESTING	28
J.19	RODENT PROTECTION.....	29
J.20	DUCT SEALING TO BUILDING FABRIC	29

1 Introduction

1.1 Overview

The aim of this document is to provide new buildings with a cabling infrastructure which has high reliability, is easy to maintain and can support the applications and services of today and the future.

The specification has been written to ensure that a cost-effective solution is provided without compromising any standards or safety issues, and that all single points of failure are designed out by means of route diversity and service duplication.

This document describes the specification for the design of the network infrastructure of both fibre and copper networks for both voice and data services into and out of single and multiple building(s), and all interconnections between buildings.

It is important to note that all telecom rooms are for the sole occupancy of iSolutions and their associated voice and data distribution equipment. It is not permissible for other parties to store or install equipment within these rooms. The university standard model is for no sharing and for sole occupancy however there are limited occasions where sharing is required for multiple service providers within a single building and in which case the shared model for frames will be used. All request for shared hub room spaces must be made to iSolutions for consideration.

All aspects of this document shall be met together with all Appendices. Appendix D shall be completed and signed off before hand over for each MER and SER.

The product set has been standardised on Commscope. This product set has been selected for its high degree of reliability, quality and performance. By standardising on the Commscope product set a standard warranty for voice and data has been set for all buildings within the University of Southampton. To this effect Commscope voice and data products specified within this document shall be selected.

All installation work shall be covered by a Commscope warranty. To ensure that this happens only approved Commscope Premier and Authorised Integrators can be used.

All designs for structured cabling SHALL be undertaken by a RCCD qualified designer in strict compliance with this specification.

1.2 Specification of Criteria

Two levels of criteria are specified, mandatory and highly desirable. The mandatory requirements are described by the word “must” and “shall”; whilst highly desirable are described by the words “should”, “may” or “desirable”. Mandatory requirements shall be adhered to under all circumstances and may not be changed. Highly desirable requirements are the desired ways of design, implementation and documentation that may be changed depending on individual circumstances.

All parties shall adhere to this specification document. Any deviation from this document must be on written approval by iSolutions.

2 Definition of Terms

2.1 Definition of Terms

2.1.1 Buildings

A roofed structure enclosed by walls on all sides containing telecommunications related equipment for the transmission and reception of data, voice, video etc, signals. It may also contain equipment related processing and storage of the signal content.

2.1.2 Backbone cable

A cable that connects any combination of carrier and network devices for the transmission of multiplexed signals.

2.1.3 Channel

ISO/IEC 11801: defines a channel as “The end to end transmission path connecting any two pieces of application specific equipment. Equipment and work area cords are included in the channel, but not the connecting hardware into the application specific equipment.”

2.1.4 Consolidation point

ISO/IEC 11801: defines a consolidation point as “A connection point in the horizontal cabling subsystem between a floor distributor and a telecommunication outlet.”

2.1.5 CP link

ISO/IEC 11801: defines a CP link as “The part of the permanent link between the floor distributor and the consolidation point, including the connecting hardware at each end.”

2.1.6 Cross connect

ISO/IEC 11801: defines a cross connect as “An apparatus enabling the termination of cable elements and their cross-connection, primarily by means of patch cords or jumpers.

2.1.7 Distribution Equipment Room (DER)

A room within a building or building that houses all the core network transmission and processing equipment as well as the campus backbone infrastructure

2.1.8 Entrance room

A room within the building that caters for the entry of cables into the building.

2.1.9 Pit

A box, joint box, manhole or cable chamber.

2.1.10 Pit cover

A covering lid used to seal a pit.

2.1.11 Main Equipment Room (MER)

A room within a building that houses network equipment, horizontal cabling, and building backbone cabling infrastructure.

2.1.12 Satellite Equipment Room (SER)

A room within the building that houses edge network equipment and horizontal cabling.

2.1.13 Solution

An end to end network of active and interconnecting passive devices that are required to transmit and process a stream(s) of client or application specific data.

2.1.14 Telecommunications

A branch of technology concerned with the transmission, emission and reception of signals, that is, information of any nature by cable, radio, optical or other electromagnetic systems. Telecommunications covers all forms of information whether voice, video, data etc.

2.1.15 Telecoms room

Generic term used to describe telecommunications equipment rooms and spaces, including but not limited to entrance rooms, DERs, MERs, SERs, etc

2.2 Abbreviations

AC	Air Conditioning
AP	Access Point
BD	Building Distributor
BICSI	Building Industry Consulting Service International
BMS	Building Management System
BS	British Standard
BT	British Telecom
CCTV	Closed Circuit Television
CD	Campus Distributor
CP	Consolidation Point
CPR	Construction Products Registration
DDA	Disability Discrimination Act
DECT	Digital Enhanced Cordless Telecommunications
DER	Distribution Equipment Room
EPO	Emergency Power Off
EVC	Emergency Voice Communications
F/FTP	Screened Shielded Twisted Pair
FD	Floor Distributor
GSM	Global System for Mobile Communications
HDPE	High-density Polyethylene
HVAC	Heating Ventilation Air Conditioning
IDC	Insulation Displacement Contact
IP	Internet Protocol
ISO/IEC	International Standards Organisation
LC	Lucent Connector
LJU	Line Jack Unit
LSZH / LSOH	Low Smoke Zero Halogen
MER	Main Equipment Room
OTDR	Optical Time-Domain Reflectometer
PSU	Power Supply Unit
PWS	Public Work Station
RCDD	Registered Communications Distribution Designer
RTU	Remote Terminal Unit
SER	Satellite Equipment Room
SMS	Short Message Service
STS	Static Transfer Switch
TO	Telecommunications Outlet
UPS	Uninterruptible Power Supply
UTP	Unshielded Twisted Pair
VOIP	Voice over IP

3 Cabling Systems

3.1 Overview

The topology of the cabling systems shall be set out and clearly defined in terms of design and product set.

3.2 Cabling System Structure

The cabling system shall be considered as a series of clearly defined subsystems, interconnected via active equipment that may perform media translation. The fundamental topology of the system derives from the nationally and internationally recognised standards for Generic IT Cabling Systems listed in paragraph 10 of this document. A block diagram of a diverse cabling system showing the various subsystems in relation to a building layout is shown below.

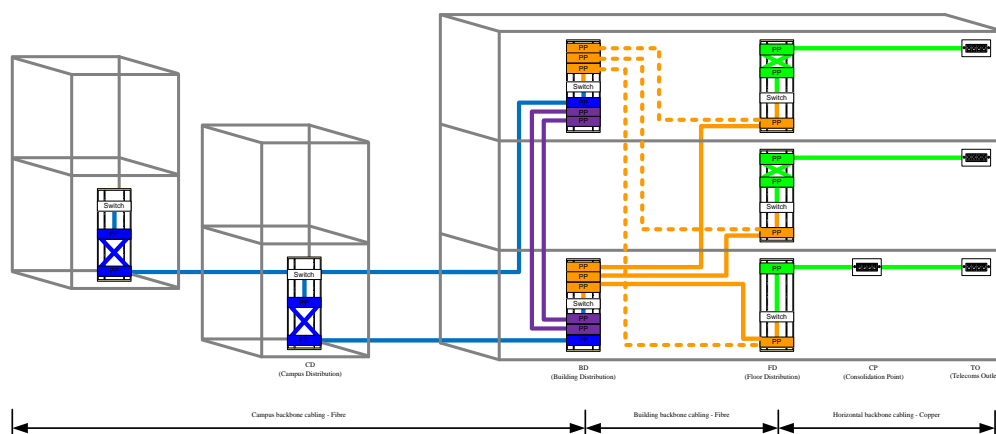

Figure 1 Building System Design with redundancy

There are three hierarchical cabling systems for any one end to end solution. The basic elements are as follows:

- Campus Backbone (Blue)
- Building Backbone (Orange)
- Horizontal Cabling (Green)

3.2.1 Campus backbone cabling subsystem

The campus backbone is the cabling subsystem that provides data and/or telecommunication services between buildings.

The following connections are provided by the campus backbone system:

- Connects Campus Distributors (CDs) on the same campus with fibre cabling infrastructure
- Connects between CDs located at remote sites via a service provider network
- Connects from CD to Building Distributor (BD) with fibre cabling infrastructure

Further details of the campus backbone cabling sub system are available in section 6 of this document.

3.2.2 Building backbone cabling subsystem

The building backbone is the cabling subsystem that provides data and/or telecommunication services between areas/floors within a building. The building backbone subsystem is only necessary in large or multi-storey buildings where distance restrictions limit use of horizontal cabling.

The following connections are provided by the building backbone system:

- Connect BD to Floor Distributor (FD) with fibre cabling infrastructure
- Connect BD to BD with fibre cabling infrastructure

Further details of the building backbone cabling subsystem are available in section 6 of this document.

3.2.3 Horizontal cabling subsystem

The horizontal cabling is the cabling subsystem that provides data and/or telecommunication services from the FD to the user Telecommunication Outlets (TOs).

The following connections are provided by the horizontal cabling system:

- Connects FD to TO with copper or fibre cabling infrastructure

Further details of the horizontal cabling subsystem are available in section 5 of this document.

4 Telecommunications Room

4.1 Overview

This section details the design criteria for all types of telecom room and their association with each other.

Telecom rooms are an integral part of a building's infrastructure. During building design, specific consideration shall be given to telecom rooms:

- Position
- Space
- Layout
- Lighting
- Ventilation
- Power
- Security
- Routing
- False floor
- Ceiling void
- Cable management

4.2 Position

4.2.1 General

The telecom rooms shall be located such that the maximum distance for horizontal and backbone cabling in the building are not exceeded.

4.2.1.1 Multiple MER Data Room Design for New Buildings

Multiple MER room design is the standard model of cabling architecture for the university. All new buildings will be provided on this model. Any relaxation of this model will need explicit permission in writing from iSolutions.

The MERs shall:

- Be separated as far as possible from each other
- Be linked together with multiple resilient fibre feeds
- Be separated as far as possible from any SERs whilst maintaining the 90m rule to the TOs
- Have a single DER feed into each MER
- Each DER feed shall be capable of servicing the load of the other DER in the event of a trunk failure
- DER trunks shall not share the same building entry
- DER trunks shall not share the same route
- All TO channel lengths shall maintain the 90m rule
- One of the MERs shall be a four rack room with UPS

The SER(s) shall:

- Be linked to each MER with a single fibre feed
- The resilient fibre feeds shall not share the same route
- All TO channel lengths shall maintain the 90m rule

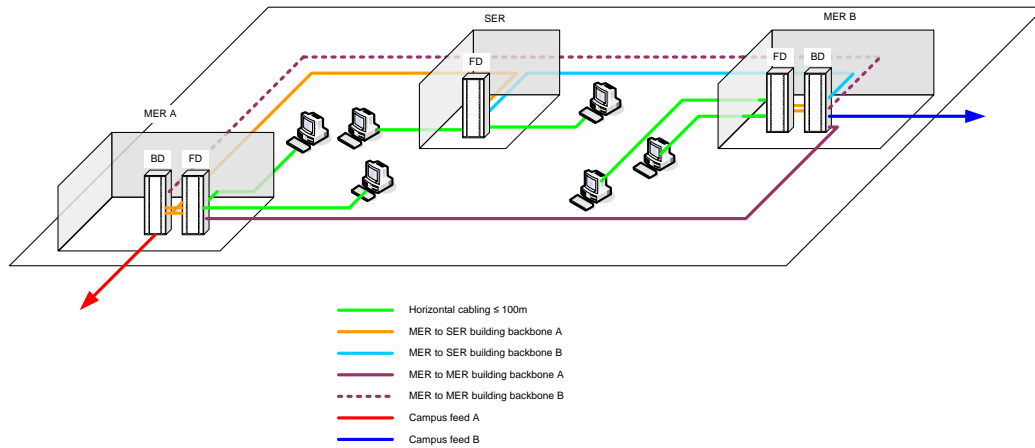

Figure 2 Multiple MER Data Room Design

4.2.1.2 Multiple Floor Data Room Design for New Buildings

Where the building contains multiple floors then a minimum of 1 telecom room shall be provided for every floor. MER A shall be located on the lowest floor and MER B on the highest. Figure 3 below shows a typical scenario.

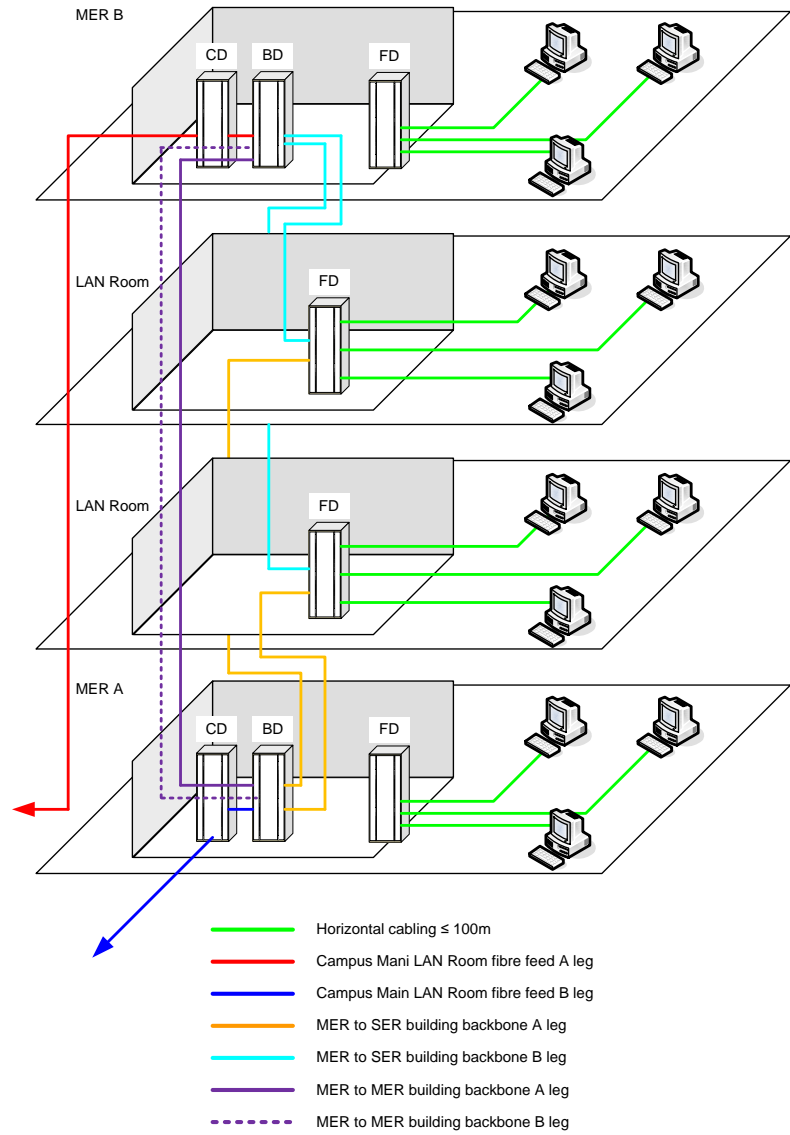

Figure 3 Multiple Floor Data Room Design

4.2.2 Siting Telecom Rooms

The rules for siting telecom rooms are:

- Avoid areas that may limit any future expansion e.g. adjacent to areas containing heavy plant, lifts or other such equipment.
- In areas where flooding is a potential threat all telecom rooms shall be sited one floor above the maximum flood level. Flooding can be defined as land which would flood with an annual probability of 1 in 20 (5%) or greater in any year, or is designed to flood in an extreme (0.1%) flood.
- In multi-storey buildings that can be serviced by a single MER it should be located central to the building.
- In a multi-storey building that requires one or more MERs and one or more SERs the MERs should be on the lower most floor.
- Where security is a concern the telecom room, where possible, shall not be sited against external walls. Basement floors are desirable followed by floors above the ground floor.
- Shall be located away from high-level sources of EMI.
- Shall be sited with its own access from a major thoroughfare– not acceptable to gain access via smaller rooms i.e. classroom, lecture theatre, private office, etc.
- Shall not be sited within a plant room, or off an office, laboratory or other occupied space.
- Should be positioned adjacent to main ICT risers on each floor
- No wet services or liquid to run through or above telecom rooms.
- Mechanical and electrical services not intended for use within the Telecom shall not run through the telecom room i.e. electrical cables, gas pipes, steam pipes
- HVAC ducting shall not use the telecom room as a route, it shall only terminate within the room
- Shall not be located adjacent to or below wet rooms i.e. bathroom, kitchen laboratory areas etc.
- Mechanical risers must not be located near telecom rooms.

4.3 Size of Telecom Room

4.3.1 General

The telecom room shall be designed to accommodate all the known and planned requirements for the equipment it shall house. Rooms serving horizontal cabling to a building shall be designed to accommodate all floor areas that are to be used as office areas, or could accommodate office areas.

Calculation of floor space is dependent on the purpose of the telecom room. All calculations shall be based on an interconnect channel design with access layer switches only.

Interconnect with Switches – A design where the telecom room only houses switches and patch panels. The switches patch directly into the distribution patch panel.

The telecom room sizes shall be as follows:

- MER A – 5 cabinets
- MER B – 2 cabinets
- SERs – 2 cabinets

It is important to note that the below telecom room sizes are the absolute maximum allowable on completion of the project e.g. if a telecom room is to have 385 outlets installed by the end of the project the telecom room size shall be as defined by a 720 channel telecom room. However, it is not the maximum number that the telecom room can cater for as an allowance has been made for future expansion. The day 1 room capacity and future capacities are:

- 360 Channels on project completion – 1 to 360 on completion of project
- 720 Channels on project completion – 361 to 720 on completion of project
- 1440 Channels on project completion – 721 to 1440 on completion of project

All telecom rooms shall have:

- $\geq 1200\text{mm}$ between the wall/equipment/services and each row of cabinets – if equipment or services protrude from a wall the $\geq 1200\text{mm}$ shall be taken from the furthest protrusion –see figure 14 for example showing a UPS
- $\geq 1200\text{mm}$ between each row of cabinets
- $\geq 1200\text{mm}$ at one end of cabinet row and any other equipment/cabinets/ramps
- $\geq 300\text{mm}$ at the other end of cabinet row and any other equipment/cabinets/ramps
- Headroom from finished floor level to the ceiling slab $\geq 3500\text{mm}$
- Unobstructed height above finished floor level $\geq 2600\text{mm}$
- Raised floor $\geq 300\text{mm}$ from floor slab to underside of false floor
- Floor loading $\geq 8\text{kn/m}^2$
- Room shall be rectangular shaped
- Door to align as near as possible to wall facing the front of the cabinets for single row of cabinets
- Door to align with centre of cold aisle for double row of cabinets i.e. front of both row of cabinets

All buildings shall have a two MER design, designed with a central UPS protection to all telecom rooms.

4.4 Telecom Room Layout

The following are examples of requirements.

The layouts do not change between the general office, residential and student learning. For rooms with limited access space, an open frame design may be considered, however this shall be confirmed on a case by case basis with iSolutions before a design is advanced.

4.4.1 MER B and all SERs

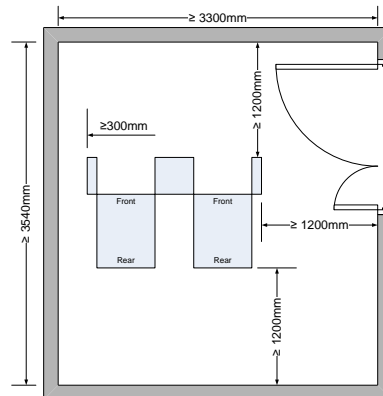

Figure 4 Telecom room layout for MER B and SERs

4.4.2 MER A

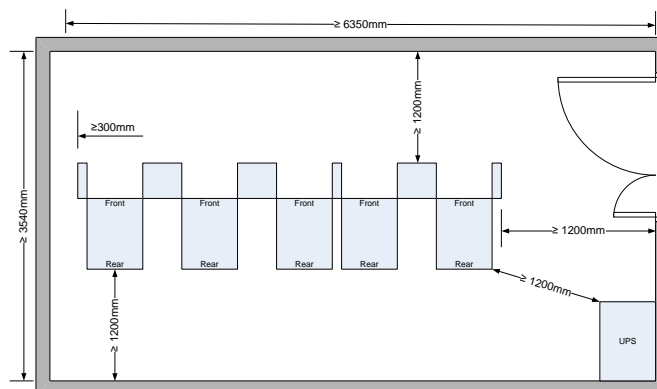

Figure 5 Telecom room layout for MER A with UPS

Note – the telecom room layout showing the UPS and five cabinets shall be used for one of the MERs where the building design has two MERs. This design shall also be used where iSolutions deem a single MER building of critical importance.

4.5 Open Space Layouts

Open space layouts are where there is no telecoms room and the cabinets or wall boxes are installed in public access or semi secure areas such as plant rooms, dry risers, storage areas etc. All designs shall be based on an interconnect model with access layer switches only.

All wall mounted boxes and cabinets shall be:

- $\geq 2000\text{mm}$ above finished floor level

- $\geq 150\text{mm}$ below finished ceiling level
- $\geq 300\text{mm}$ on both sides from walls and obstacles for wall boxes
- $\geq 700\text{mm}$ on both sides from walls and obstacles for wall mounted cabinets

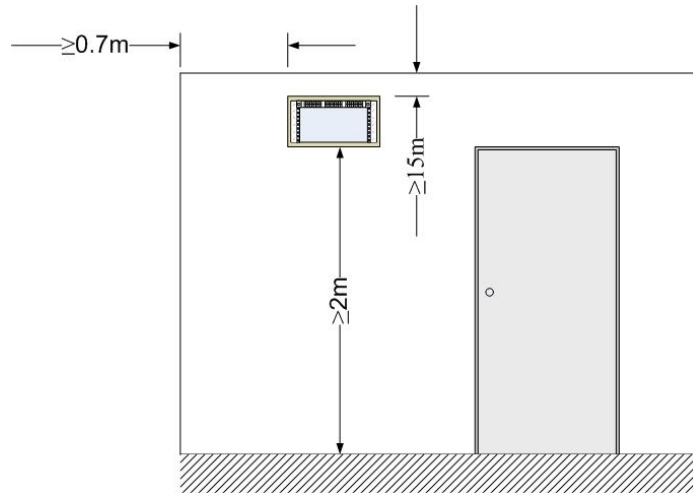

Figure 6 Desirable wall mounted box and cabinet clearances

4.5.1 Single Rooms

Where the requirement for $\geq 2000\text{mm}$ above finished floor level cannot be met wall mounted cabinets shall not be installed in areas shaded red.

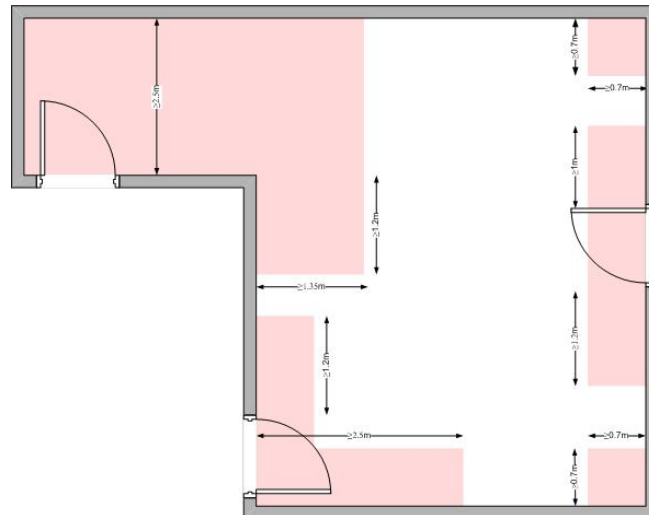

Figure 7 Single room clearances for wall mounted cabinets

4.5.2 Corridors and Throughways

Wall mounted boxes and cabinets shall be installed with 2000mm of floor clearance and 150mm ceiling clearance in all major corridors, throughways and fire exits.

Rooms that act as a throughway, but not designated as one, can have wall mounted cabinets installed below 2m if the minimum width of the throughway is $\geq 2.5\text{m}$.

In none designated throughways where the requirement for $\geq 2000\text{mm}$ above finished floor level cannot be met wall mounted cabinets shall not be installed in areas shaded red.

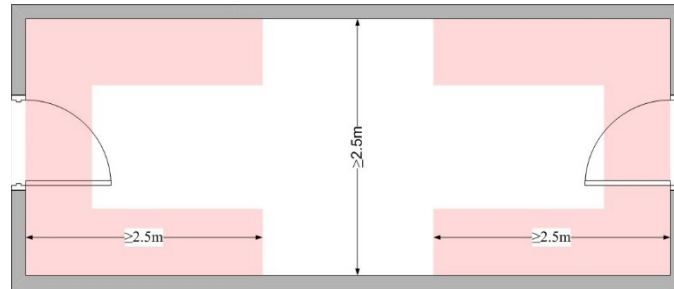

Figure 8 None designated throughway clearances for wall mounted cabinets

4.5.3 Cabinet Sizing

Cabinet depths:

- up to 9U shall be $\geq 400\text{mm}$ in depth
- greater than 9U in height shall be $\geq 600\text{mm}$ in depth

Unit	Max No of 24 port patch panels
Wall Mounted Box	1
6U Wall Cabinet *	3
9U Wall Cabinet *	5
12U Wall Cabinet *	7
15U Wall Cabinet *	9

4.6 Door Entry

The door entry shall be:

- Double door entry with no centre pillar
- Door height shall be $\geq 2130\text{mm}$
- Main door to be $\geq 900\text{mm}$ in width
- Secondary door to be $\geq 450\text{mm}$ in width
- Both doors to open inwards
- The secondary door (narrowest) to have top and bottom draw bolts into the door frame and slab respectively
- The main door to have a suitable security lock fitted with a MUL-T-Lock M50 107X tumbler lock
- To be $\geq 1350\text{mm}$ width (total opening for both doors)
- The doors shall be a solid construction with no glass panels
- Doors shall be ≥ 90 minute fire rated
- Fitted with the following signs to the main door entry side
 - Telecom room number
 - No unauthorised access
 - Laser warning
 - CCTV warning
 - Electricity warning

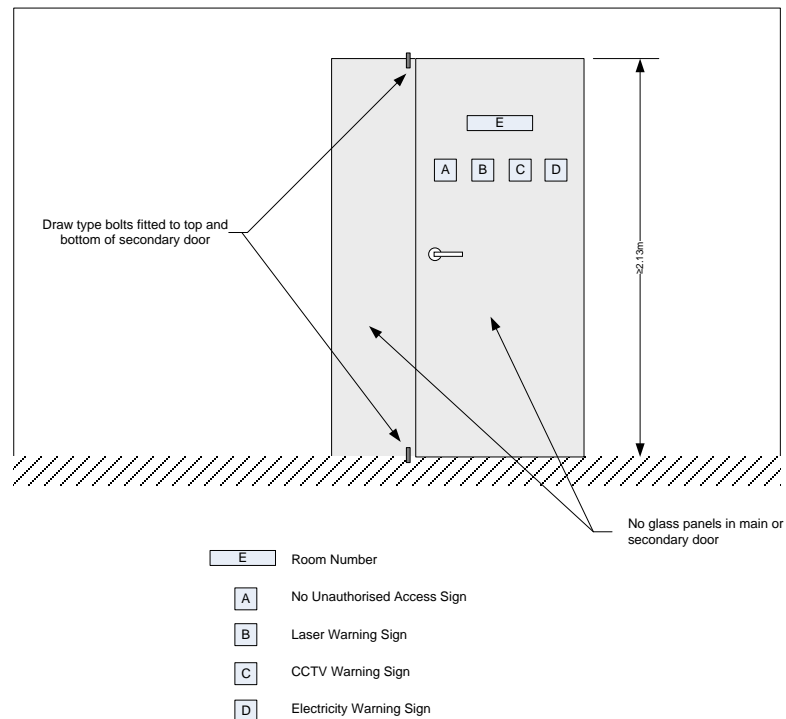

Figure 9 Telecom room door entry details

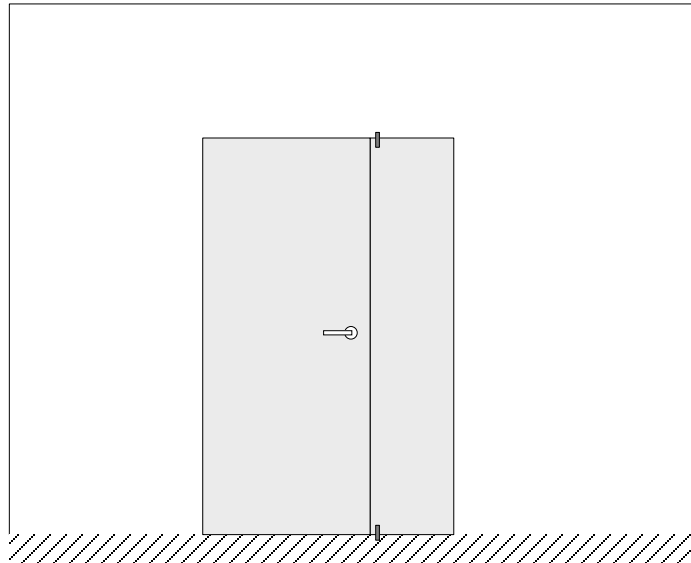

Figure 10 Telecom room door exit details

4.7 Cabinet Elevations

The layouts follow the telecom room layouts but detail how the copper and fibre patch panels and switches are laid out.

The general requirements for all cabinets are:

- Fibre Building Distribution (BD) and fibre Campus Distribution (CD) patch panel(s) shall be mounted at the top of the cabinet
- Network switches to be installed in a cabinet to the right of the structured cabling cabinet
- Network switches to be installed from the top down
- A 1U gap to be left between network switches for cooling purposes
- Network switches shall be installed in stacks of ≤ 9
- Room shall be left to enable each stack to reach a maximum of 9 i.e. if there are two stacks of 5 switches then an 8U gap shall be left between each stack of 5 switches

4.7.1 SER Cabinet Layout

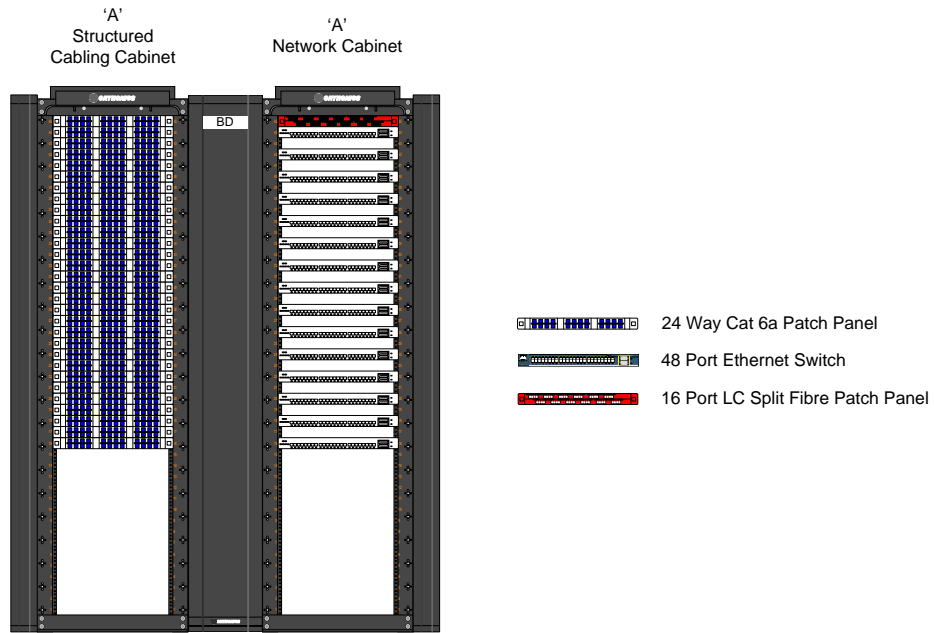

Figure 11 SER cabinet layout

4.7.2 MER B Cabinet Layout

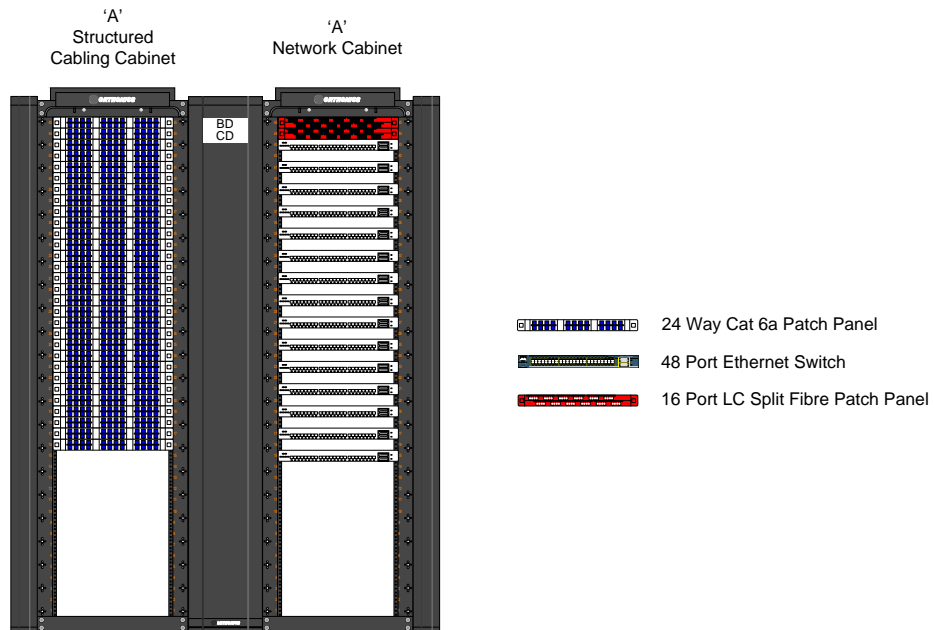

Figure 12 MER B cabinet layout

4.7.3 MER A Cabinet Layout

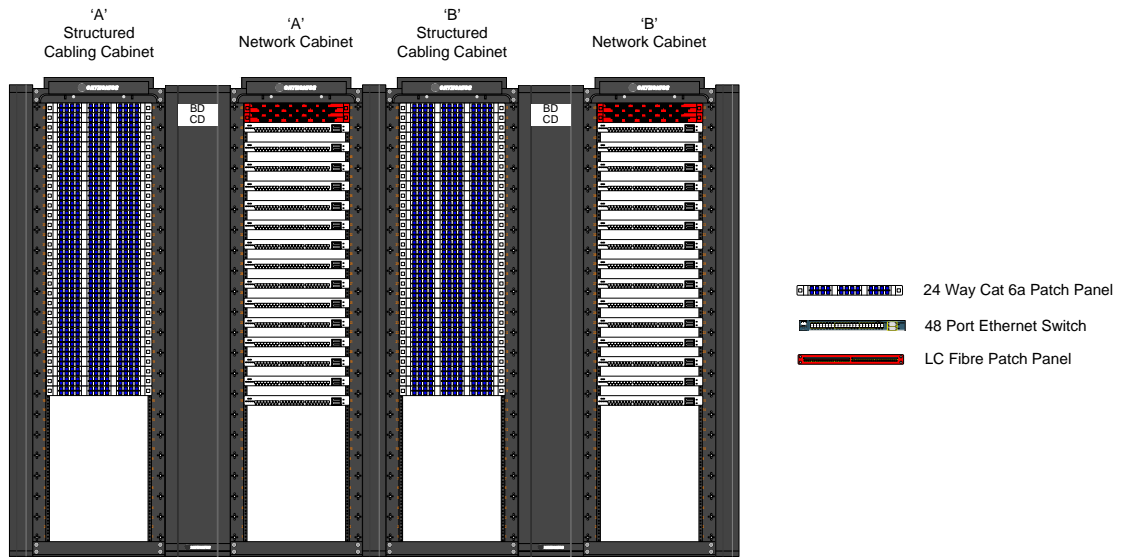

Figure 13 MER A cabinet layout

4.8 Lighting

4.8.1 Lighting Design

All telecom rooms shall have no suspended ceiling installed.

Lighting shall be in the centre of the aisles, not above racks, containment etc.

Lighting shall be measured 1m above the finished floor in the centre of the hot and cold aisles. The luminance shall be a minimum of 500lx in the horizontal and 200lx in the vertical plane. Diffusers shall be used to ensure an even spread of light throughout the length and width of the aisles. Spot lighting shall not be used to illuminate the aisles.

The light fixtures shall be Philips SmartForm LED panel (BPS460 LED 48/840 PSD W22L124 MLO-PC or BPS460 LED 24/840 PSD W22L124 MLO-PC) or equivalent. The layouts of the SmartForm panels must be as detailed below.

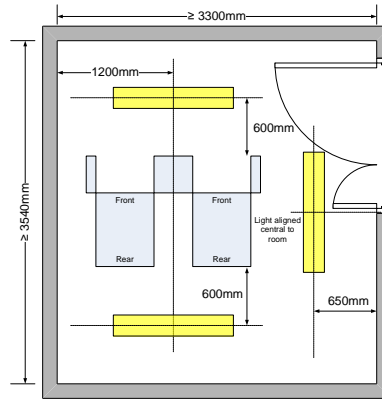

Figure 14 Lighting layout for MER B and SERs

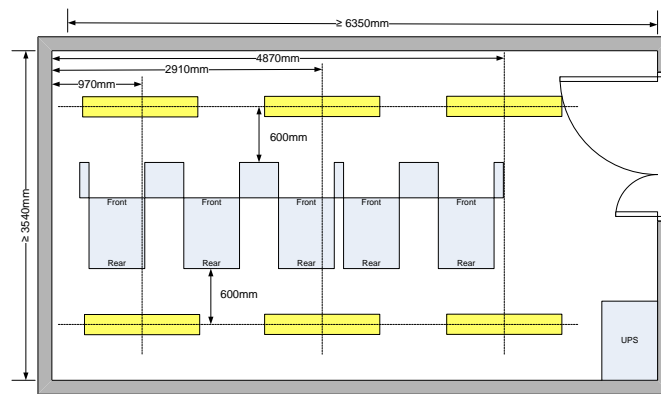

Figure 15 Lighting layout for MER A

Note – the telecom room layout showing the UPS and five cabinets shall be used for MER A.

4.8.2 Lighting Measurements

Lighting shall be measured in the horizontal plane:

- At 1m above the finished floor
- 600mm from the front face of the rack's vertical managers
- 600mm from the rear face of the rack
- In the centre of the aisle to the right and left of the row of racks
- The luminance shall be a minimum of 500lx

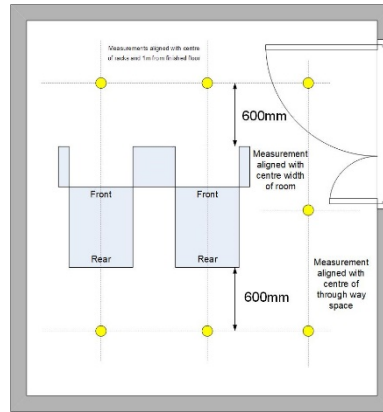

Figure 16 Lighting measurements for MER B and SERs

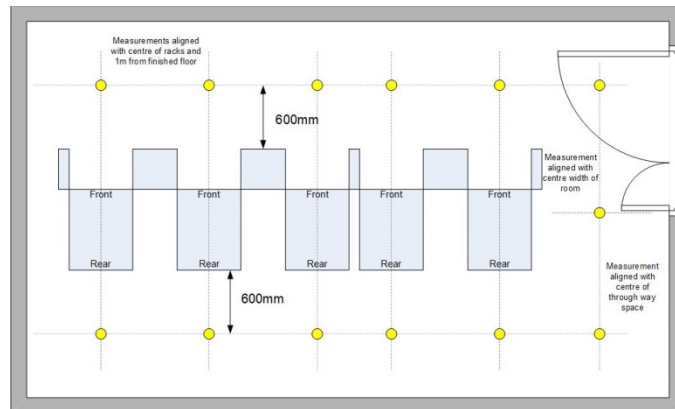

Figure 17 Lighting measurements for MER A

Lighting shall be measured in the vertical plane:

- At 5U, 22U and 40U in each rack
- At the front face of the patch panels or network equipment
- At the rear face of the rack
- The luminance shall be a minimum of 200lx

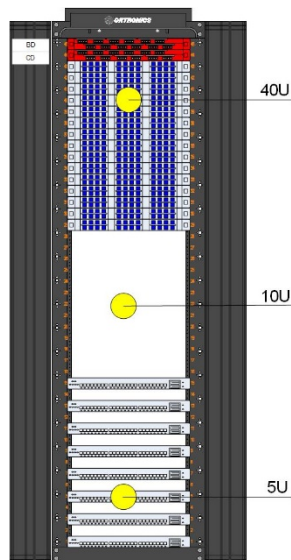

Figure 18 Front view of cabinet lighting test points

4.9 Cooling

The telecom room shall be provided with free cooling ventilation and supplemented with air conditioning. Consideration shall be taken for future power requirements of new equipment. A suitable margin above the flood-wiring scenario shall be taken into account. To allow a safety margin of cooling it shall be designed to accommodate the requirements of flood wiring with all ports active.

4.8.1 Telecom Room Requirements

Each Telecom room shall have:

- Internal temperature sensors
 - One TREND sensor to be plugged into the TREND Network
Mounted a side wall
- External temperature sensor
 - Where the telecom room is above the ground floor it shall be mounted >300mm to the telecom room window opening
 - It shall not be mounted directly above a window opening
 - It is preferred to be mounted below a window opening
 - Shall not be mounted within 1m of extractor fan
 - Shall not be mounted above any extractor fan
 - Shall not be directly exposed to solar radiation
 - Shall not be painted
 - Shall not be mounted on external facades that transmit convective heat i.e. metal clad buildings
- TREND controller
 - Inputs for
 - External temperature sensor
 - Internal temperature sensor
 - Output for DX unit – enable and disable function
 - Input from DX unit – fault condition
 - Output for supply fan – enable and disable function
 - Output for extractor fan – enable and disable function
 - Output for air recirculation damper
 - Output for fresh air damper
 - To be mounted on an internal wall within the telecom room

- To be protected from damage misuse with a lockable wall mounted unit
- DX Unit
 - N for all MERs
 - N for all SERs
 - Where a room has N cooling resilience the DX units shall be fed from the UPS distribution board
 - Each DX unit shall be capable of supplying a minimum of 5kW of cooling for each cabinet housing active equipment
 - 21⁰C to 26⁰C for telecom rooms with no UPS
 - 16⁰C to 21⁰C for telecom rooms with a UPS
 - The DX units shall be enabled on an 8k temperature gradient (ΔT) between the buildings external and telecom rooms internal temperature
 - For telecom rooms with no UPS the DX unit is enabled and the extractor fan is disabled when the external temperature is $\leq 18^{\circ}\text{C}$
 - For telecom rooms with no UPS the DX unit is disabled and the extractor fan is enabled when the external temperature is $> 18^{\circ}\text{C}$
 - For telecom rooms with a UPS the DX unit is enabled and the extractor fan is disabled when the external temperature is $\leq 13^{\circ}\text{C}$
 - For telecom rooms with a UPS the DX unit is disabled and the extractor fan is enabled when the external temperature is $> 13^{\circ}\text{C}$
 - A digital temperature controller with LCD display to allow a user to set and display fan speed, temperature gradient, temperature setting etc.
 - Lowest most DX unit to be mounted $\geq 2\text{m}$ from the final floor level
- Free cooling fans
 - An extractor fan with air damping when disabled
 - A supply air fan with fresh air supply damper and air recirculation damper
 - Where both fans are on the same external wall, they shall be $\geq 2\text{m}$ apart
- The cooling system shall be tested and commissioned prior to the installation of active equipment. The active equipment covers, but is not limited to, UPS, network switches etc.
- The cooling system shall be available of a 24 hour 365 day basis
- The telecoms room shall be protected against contaminants and pollutants

Contaminant	2 Concentration
Chlorine	0.01 ppm
Dust	100 $\mu\text{g}/\text{m}^3/24\text{ h}$
Hydrocarbons	4 $\mu\text{g}/\text{m}^3/24\text{ h}$
Hydrogen Sulphide	0.05 ppm
Nitrogen Oxides	0.1 ppm
Sulphur Dioxide	0.3 ppm

Table 1 - Contaminants List

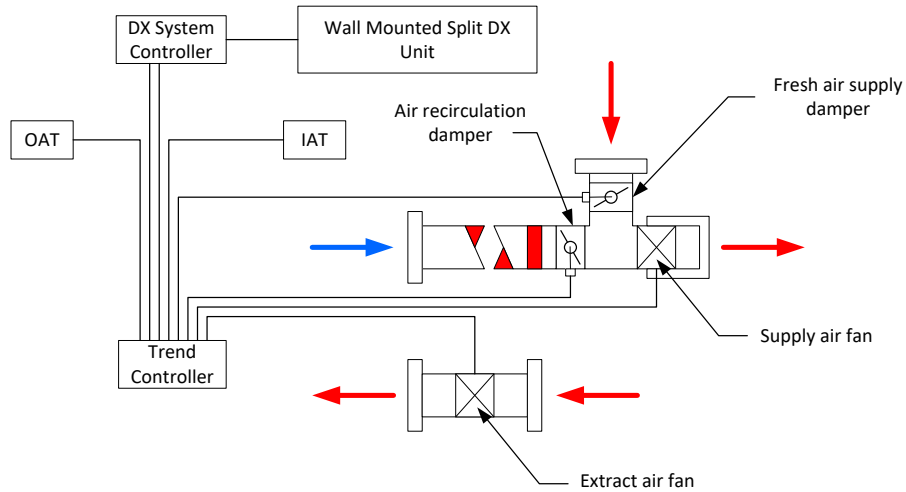

Figure 19 Logical diagram for cooling system

4.8.2 Free Cooling Room Layouts

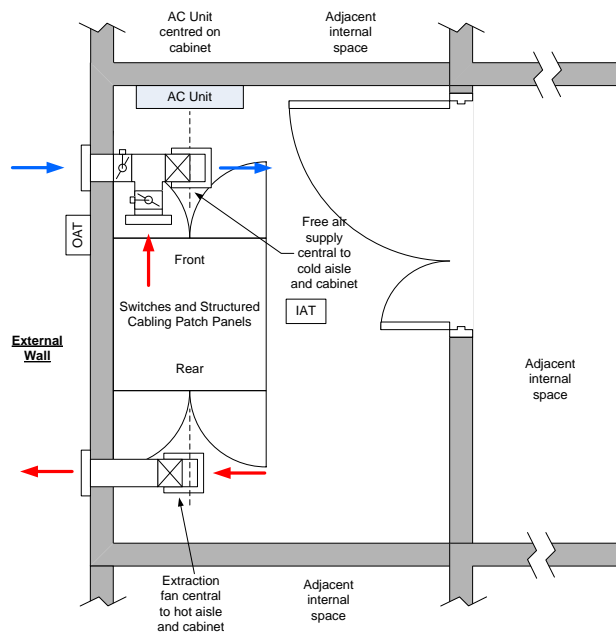

Figure 20 Example layout for a single external wall

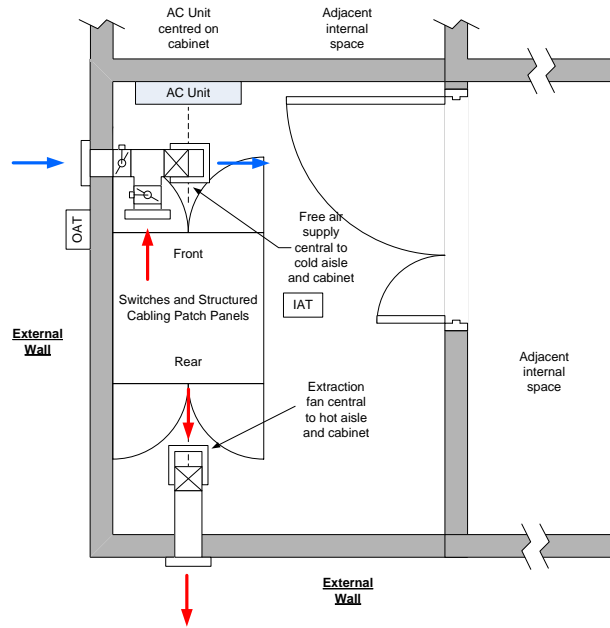

Figure 21 Example layout for a 2 adjoining external walls

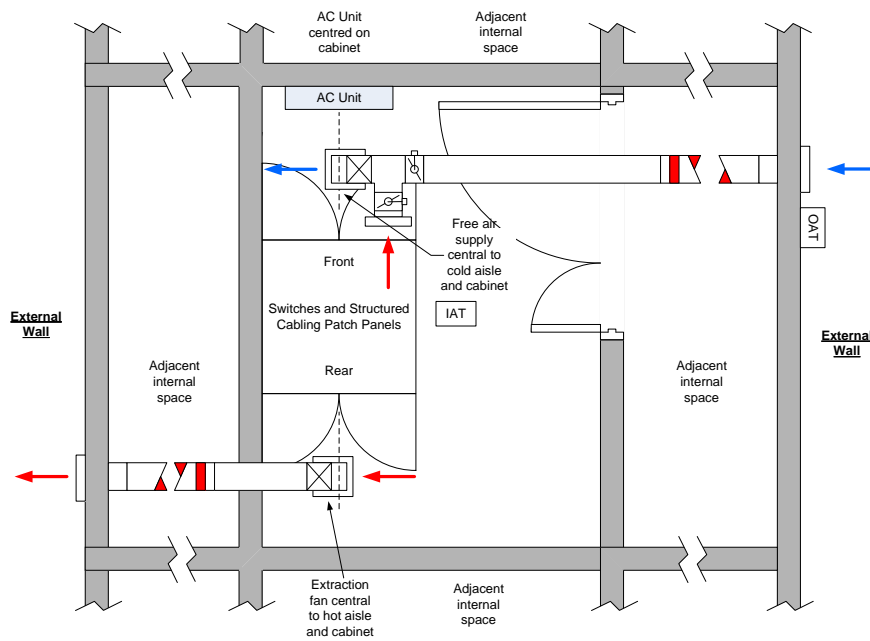

Figure 22 Example layout for 2 adjacent external walls

4.8.3 DX Cooling Room Layouts

All AC units shall point forwards towards the front of the racks.

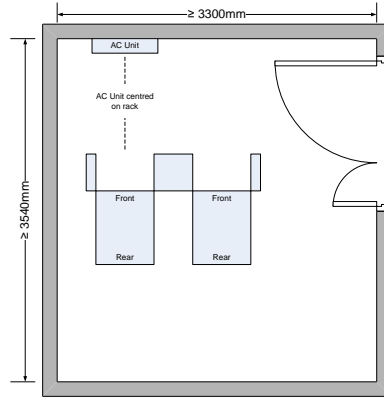

Figure 23 DX layout for MER B and SERs

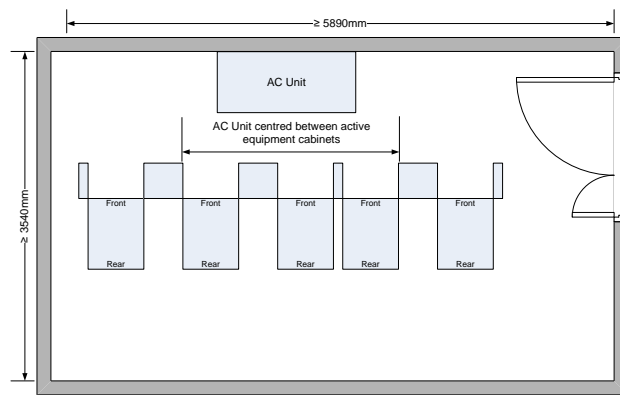

Figure 24 DX layout for MER A with UPS

4.10 Power

Each Telecom room shall have:

- A local none UPS distribution board in MER
 - Sufficient breakers for
 - One breaker for the UPS
 - One breaker for the 13A twin sockets
 - One breaker for the lighting
 - 4 spare breaker positions
- A local UPS distribution board in the MER
 - Sufficient breakers for
 - One breaker for each SER
 - One breaker for the HVAC unit
 - One breaker for each commando socket within the MER
 - 4 spare breaker positions
- A local none UPS distribution board in SER
 - Sufficient breakers for
 - 13A twin sockets
 - Lighting
 - 4 spare breaker positions
 - 4 spare breaker positions
- A local UPS distribution board in the SER – linked to the UPS board in the MER
 - Sufficient breakers for
 - One breaker for each commando socket within the SER
 - One breaker for the HVAC unit
 - 4 spare breaker positions
- All commando socket breakers shall be MCB Type C
- All breakers shall be labelled
- Two Raritrans for each cabinet/rack housing active equipment
 - 240v 32A rating
 - All commando sockets within a single cabinet/frame shall be on the same phase
 - Commando plug termination
 - For high level containment the commando sockets shall be directly above the cabinet/rack – one aligned to the rear left hand side and one to the rear right hand side of the cabinet/rack
 - For low level containment the commando sockets shall be directly underneath the cabinet/rack– one aligned to the rear left hand side and one to the rear right hand side of the cabinet/rack
 - Diverse route to UPS distribution board within the MER or SER and on the same phase
 - Each commando to have its own circuit breaker
 - All commando sockets shall be fed from the UPS distribution board
 - All commando sockets shall be labelled
- Two Raritrans (part no. PX3-1493V 32A) for each cabinet housing active equipment
 - 240v 32A rating
 - 4 way C19
 - 20 way C13
 - 3m cord
 - Un-switched
 - Metered
 - Diverse route to intended commando socket
 - Commando plug termination
 - 2 mounting brackets per PDU (part No. 251-01-0026-00)
 - All PDUs shall be labelled
- One Raritrans temperature sensor (part no. DPX-T1)
 - Positioned at the rear of the frame central to the top rail

- Plugged into PDU
- One Raritrans temperature sensor (part no. DPX-T1)
 - Positioned at the front of the frame central to the top rail
 - Plugged into the PDU
- All mains leads shall be labelled
- Cabinets/frames not housing active equipment shall not have PDU's fitted.
- MER B and SERs shall have a minimum power rating of 5kW
- MER A shall have a minimum power rating of 15kW
- A minimum of 2 off double 13A switched sockets fed from the local distribution board
- All cabinets/frames shall be separately earth bonded using a minimum of 6mm earthing cable back to a grounding bar located within the Telecom room. Bonding shall be in accordance with BS 7671.

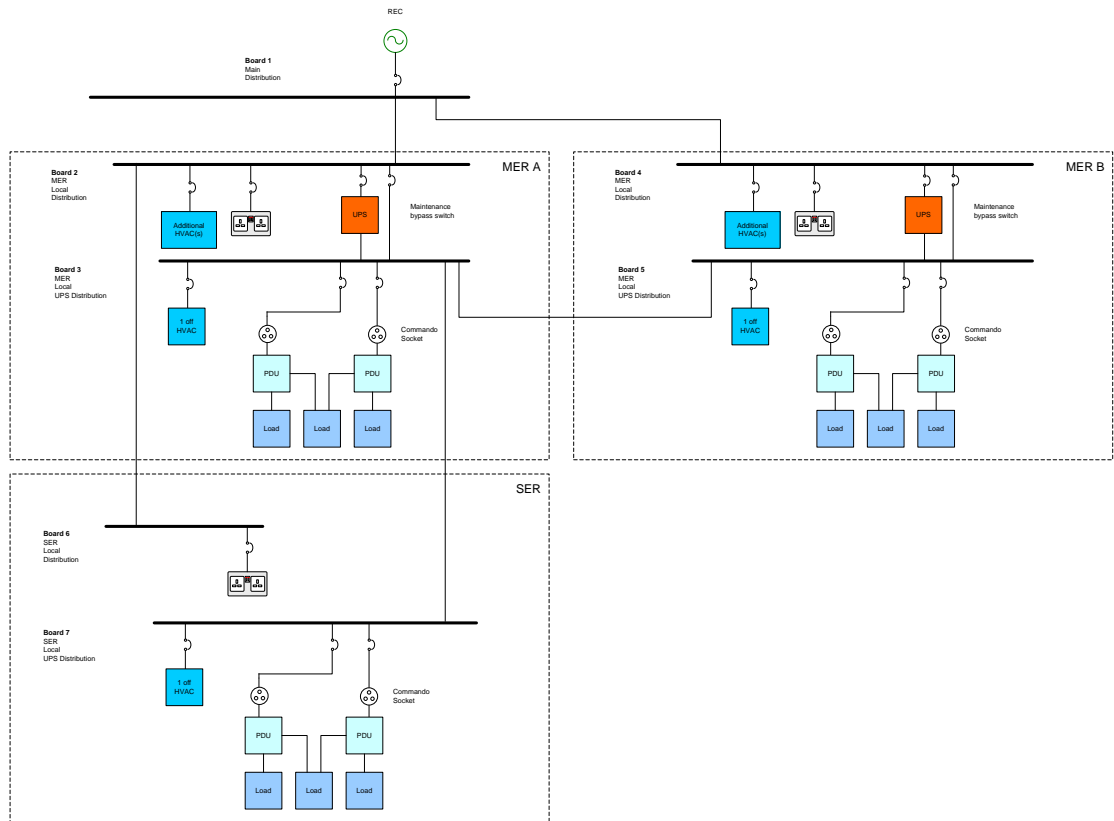

Figure 25 Telecom room power arrangements

4.11 UPS

All new buildings shall be provided with a UPS system located in the MER(s). The requirements shall be:

- A Vertiv 3 phase UPS will be supplied and fitted
- The full specification for the UPS shall be sought from the University
- The Main Contractor shall correctly size the UPS for operational capacity and battery autonomy based on the loads given in this specification
- This UPS shall be located in the MER and feed a UPS distribution board in each SER, MER A and MER B within the building
- The UPS shall be fitted with an appropriate communications card and shall be connected to the Vertiv Life.Net service
- Loads shall be balanced across the UPS phases
- Each rack shall be fed with single phase power
- The UPS within the MER shall be commissioned, integrated and fully operational prior to the MER hand over
- An external manual bypass facility will be provided to allow the UPS to be taken completely out of circuit to allow maintenance or replacement operations without affecting the output loads
- A commissioned UPS with the communications card reporting to the Life Net service is required as part of practical completion

4.11.1 N Redundancy

Where a building requires an N redundant UPS system it is important that the UPS loading be carefully considered. A centralised UPS solution will be supplied. All network equipment essential for the operation or security of the network shall be connected to the UPS system. The Main Contractor shall provide a UPS design and shall submit this design to iSolutions for approval. A typical UPS layout is shown below.

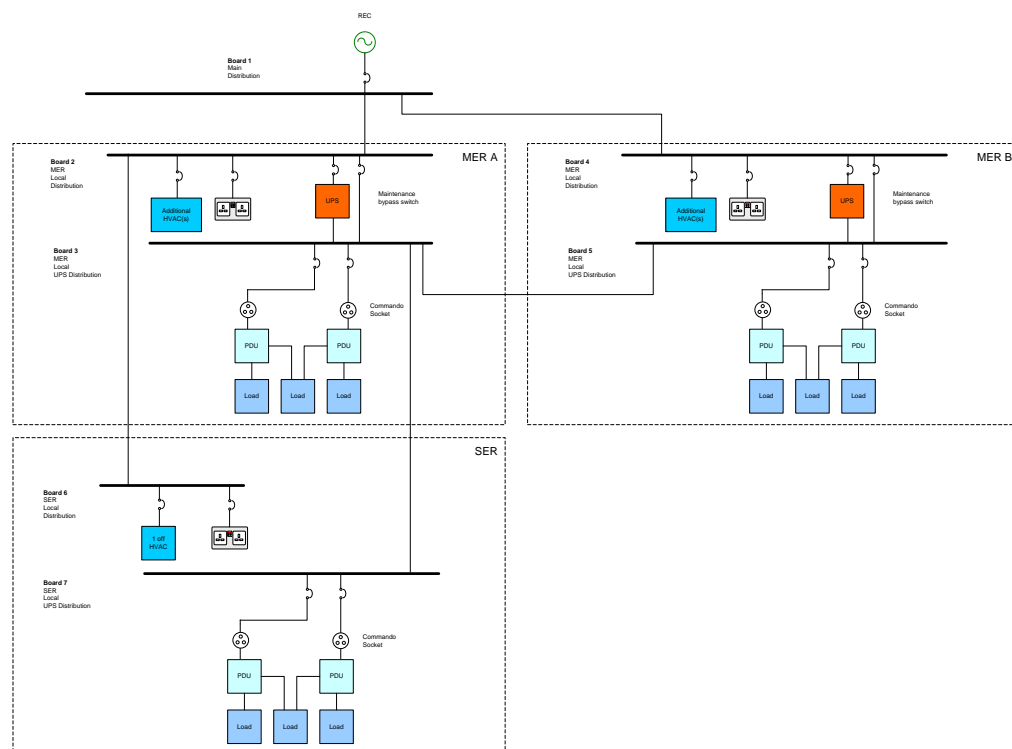

Figure 26 Typical N redundant UPS system

The specification for an N redundant UPS system is:

- 20 minute backup for non-generator backed sites
- Training for a maximum of 6 people on site
- Manufacturer 4 hour fault response service contract will be provided for a five year period
- Ethernet alarm connection
- External maintenance bypass interface
- Emergency Power Off (EPO) – A STS anti-tamper enclosure shall be fitted
- Batteries shall be sealed type – replacement batteries shall also be sealed type. It is not acceptable to fit vented batteries

4.12 Power over Ethernet (PoE)

Any anticipated requirements for PoE shall be discussed with iSolutions in advance.

4.13 Environmental Monitoring

Two Raritan DPX T1 temperatures sensors shall be fitted each active frame, one sensor to be mounted at U30 position on the front and one to be mounted at U30 at the rear of the active frame. Both sensors will be plugged in to the Raritan frame PDU,s, which are to be networked.

A Logitech® Webcam® Pro 9000 will be supplied and connected to the second PDU.

The camera will be positioned to look at the entrance door and have an unobstructed view with the door closed or open.

4.14 Internal Cable Tray

4.14.1 Telecom Room High Level Containment

High level containment shall meet the requirements of section 5.9 Cable Management and the below statements:

- Where cables enter a telecom room from high level the cables shall be installed on suspended cable basket
- The cable basket shall be sized to accommodate the maximum number of cables of completion of the project/installation plus 25%
- The absolute minimum size of cable basket shall be 600 x 50/60mm.
- The high level cable basket shall run parallel with the cabinet(s), be aligned with the front of the cabinets and finish a minimum of 150mm beyond the last waterfall.
- All data containment shall be installed as the lowest service containment as it is accessed on a higher frequency than any other service.
- Telecom rooms shall not be fitted with suspended ceilings.
- All cables leaving the cable basket for entry into a cabinet shall be supported with aluminium or powder coated steel waterfalls.

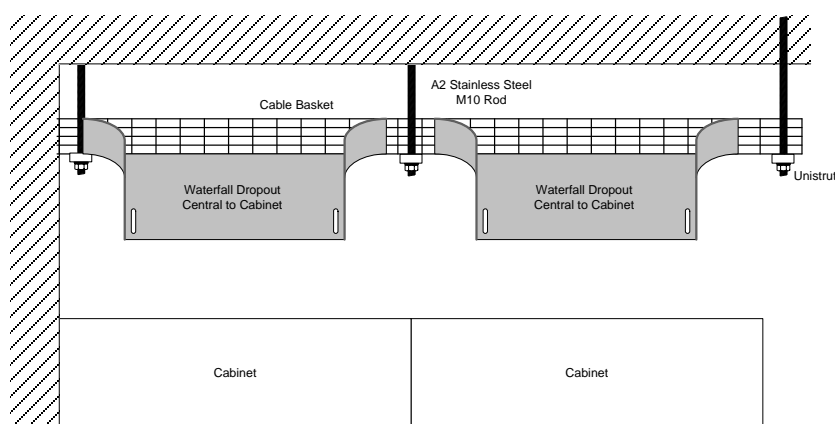

Figure 27 Example of waterfall Dropouts

- The basket shall be suspended on Unistrut bars held in place by A2 stainless steel M10 threaded rods

- The threaded rods shall be secured to the ceiling slab and be capable of holding the weight of the maximum number of cables plus a safety margin of 100%
- The length of the Unistrut bars shall, as a minimum, be the width of the cable basket plus 100mm.

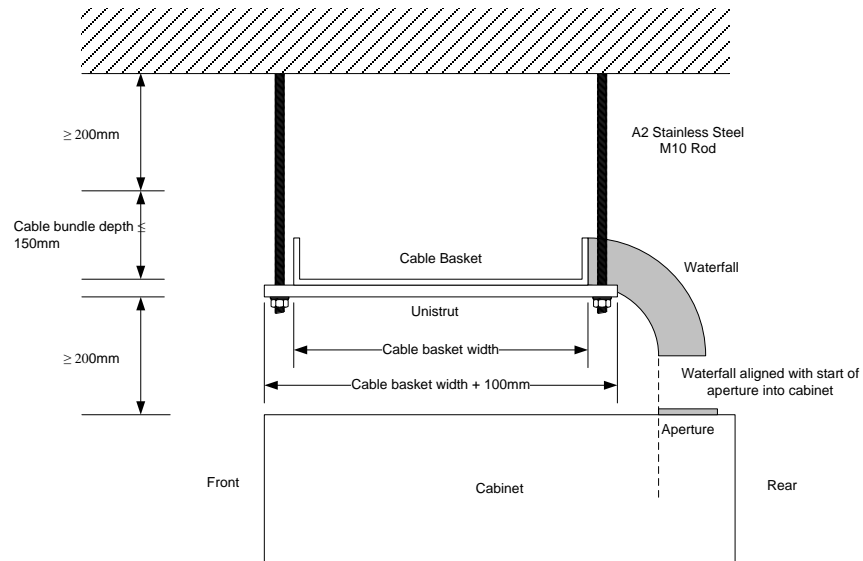

Figure 28 High level containment with no suspended ceiling

- The Unistrut trapeze fixings shall be installed as follows:
 - First trapeze – 50mm
 - Intermediate trapeze – centred on the junction between two cabinets
 - Last trapeze – 50mm beyond the last cabinet
- The cable basket shall extend from the room entry to within 120mm to the finish of the last cabinet.

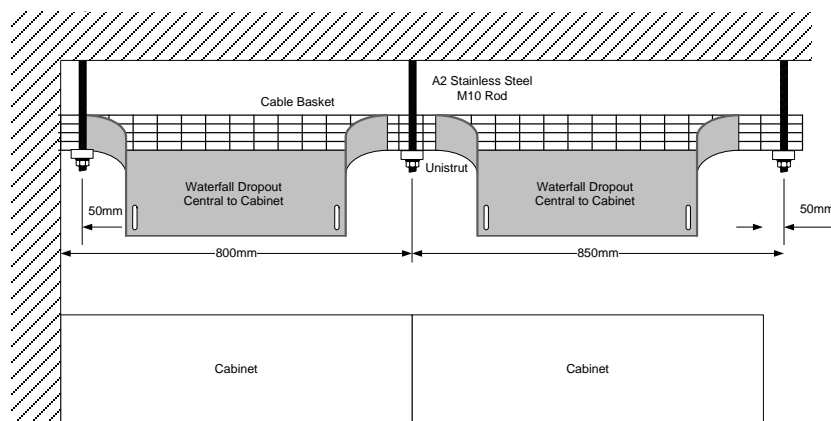

Figure 29 High level containment within a suspended ceiling side elevation

4.14.2 Telecom Room Low Level Containment

Low level containment shall meet the requirements of section 5.9 Cable Management and the below statements:

- Where cables enter a telecom room from low level the cables shall be installed on cable basket held off the floor with Unistrut
- The cable basket shall be sized to accommodate the maximum number of cables of completion of the project/installation plus 25%
- The absolute minimum size of cable basket shall be 600 x 50/60mm.
- The low level cable basket shall run the full length of the cabinet(s) and be positioned directly under them.
- The cable basket shall start flush with the wall at the cable entry point
- The cable basket shall be mounted on 41mm Unistrut bars with 300mm between bars
- The Unistrut bar length shall be equal to the width of the cable basket and sit central to the cable basket.
- The minimum height from the top of a cable bundle to the underside of the suspended floor shall not be less than 50mm
- The minimum height from the underside of the cable basket to the finished surface of the floor is 41mm.
- All cables within suspended floor voids shall be laid on cable baskets to a depth of no more than 150mm.

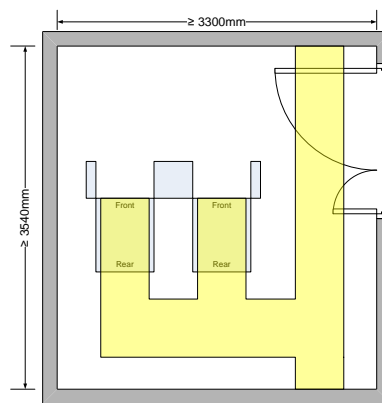

Figure 30 Suspended floor containment for MER B and SERs

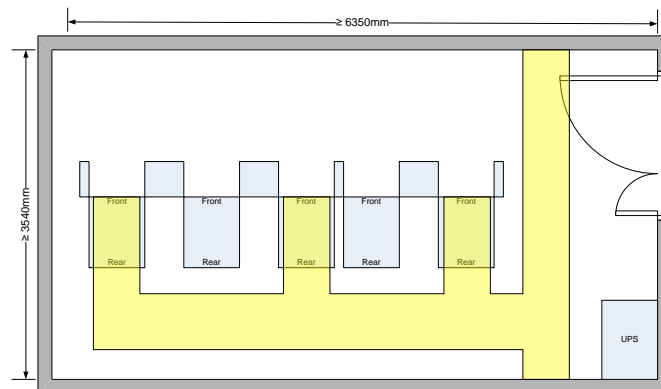

Figure 31 Suspended floor containment for MER A

There shall be separate trays for power and telecommunication services. Where the trays cross, they shall be bridged and cross at 90°. Manufactured cross sections shall be fitted where containment runs cross. It is not acceptable to cut cable trays and butt them together to form a cross section.

4.15 Floor Finish

4.15.1 Suspended Floor

Where there is no suspended floor the finished floor level shall be:

- Minimum depth of 250mm from the floor finish to the underside of the floor tile
- The surface of the floor tiles shall have a smooth vinyl anti-static proof finish
- The underside shall be clad in a corrosion proof metallic material.
- All apertures cut into a suspended floor shall be sealed with brush seal Gromtec GTAG5-300-UOS or CATAG5-600-UOS.
- The suspended floor support pedestals shall not interfere with the aperture openings
- A floor tile lifting clamp shall be left in each MER and each SER
- The suspended floor shall be bonded to earth in accordance with BS 7671

4.15.9 Solid Floor

Where there is no suspended floor the finished floor level shall be:

- Cracks filled
- Deal with problematic dilatations and mould lines
- Deep clean
- Treat with two coats of blue coloured ESD coating to EN 61340-4-1, EN 61340-4-5 and EN 61340-2-3
- Treat with one clear coat of ESD coating to EN 61340-4-1, EN 61340-4-5 and EN 61340-2-3
- None slip finish

4.16 Acoustic Performance

All walls, doors, ceilings and floors shall have an acoustic performance of not less than R_w , R_w+C_{tr} of 60/50.

All walls shall be sealed and filled prior to handover.

4.17 Cable Penetration

Where cables penetrate a telecom room the following shall apply:

- An aperture shall be cut into the telecom room that is sized to allow the complete penetration of the data cable containment
- The data cable containment shall pass through the penetration with no break/joint
- Data cables shall be installed to the left of the cable basket
- All cable entry points shall be fire stopped to the required rating
- All fire stops shall be in accordance with BS 9999: latest revision.
- Fire stopping must be installed by a LPCB or FIRAS accredited contractor with a minimum of 3 years' experience
- Submit evidence that the Manufacturers products and systems are Third Party accredited by LPCB or FM (Factory Mutual)
- Two off EZ Path 100 x100mm devices shall be installed within the fire stop to the right of the data cabling

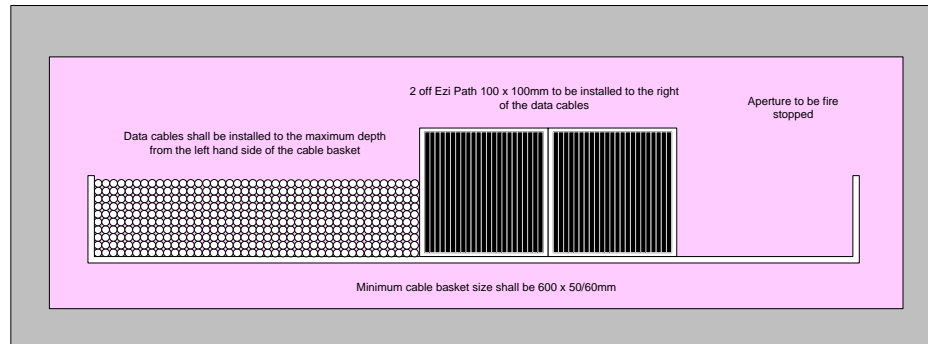

Figure 32 Cable penetration

4.18 Earth Bonding

4.18.1 MER and SER Main Bonding

For Main Equipment Rooms (MER) a copper grounding bar of dimensions $\geq 100\text{mm}$ (H) x 300mm (L) x 6mm (D) shall be fitted

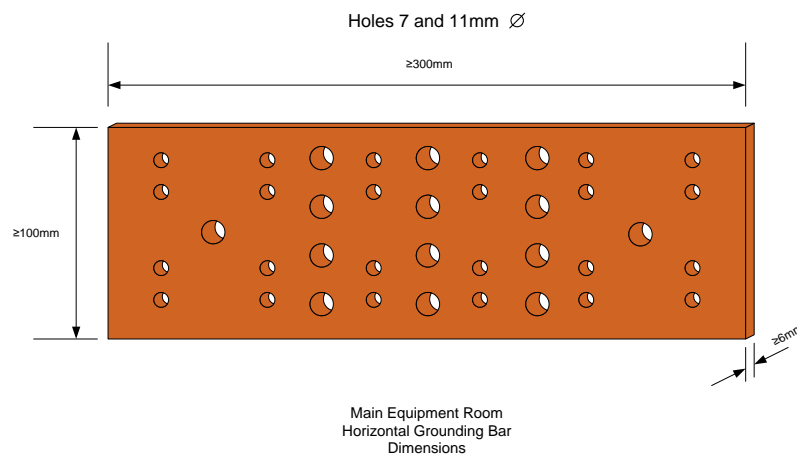

Figure 33 MER grounding bar

For Satellite Equipment Rooms (SER) a copper grounding bar of dimensions $\geq 50\text{mm}$ (H) x 300mm (L) x 6mm (D) shall be fitted.

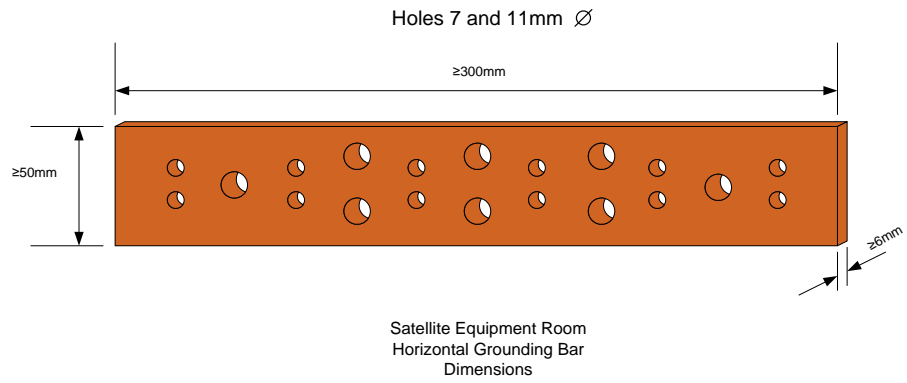

Figure 34 SER grounding bar

The telecom room copper grounding bar shall be mounted at a height of 300mm above the floor surface. The grounding bar shall be insulated from the support wall or floor to a minimum rating of 2000V

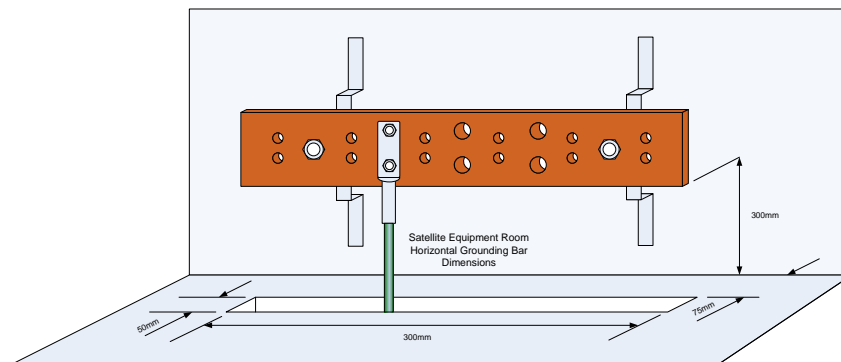

Figure 35 Grounding bar front elevation detail

Where a suspended floor is fitted it shall have an aperture cut within the floor tile to a width of 50mm and length equal to the grounding bar. Where the suspended floor provides air cooling the aperture shall be sealed with a brush seal Gromtec GTAG5-300-UOS or CATAG5-600-UOS.

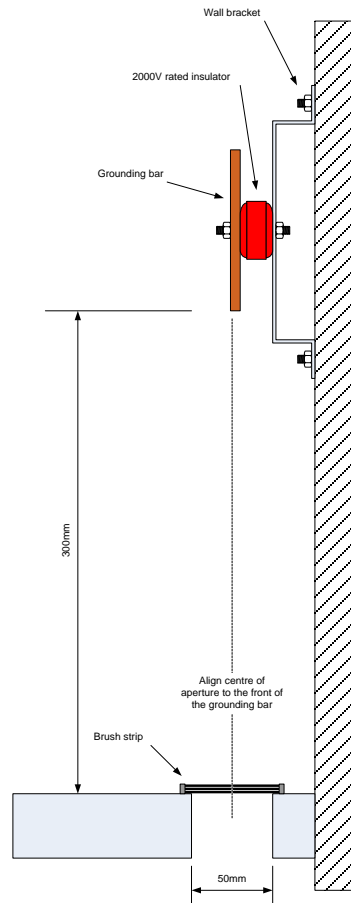

Figure 36 Grounding bar side elevation detail

4.18.2 Cabinet Grounding Bar

The cabinet/rack shall have a suitable sized horizontal or vertical grounding bar fitted. The grounding bar shall be made of copper and drilled with 7mm holes.

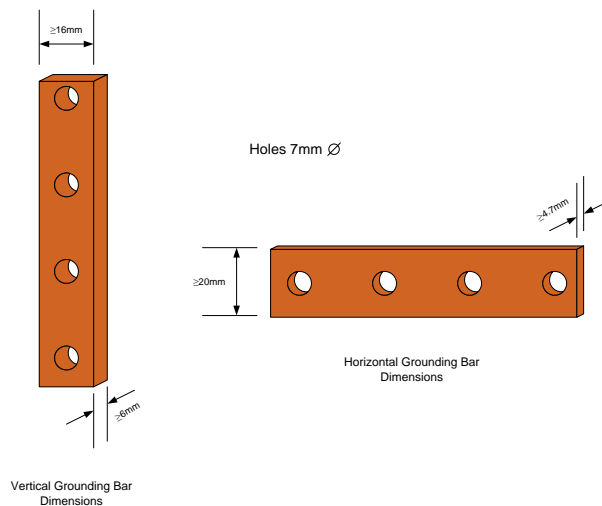

Figure 37 Cabinet grounding bar

Vertical grounding bars shall be fitted to both the rear of the left mounting angle and right mounting angle of the cabinet/rack.

4.18.3 Earth Grounding Cables for Cabinets and Voice Frames, Cabinet or Wall box

1. A tri-rated cable shall be bonded to the Telecom room grounding bar to each cabinet or voice frame, cabinet or wall box. It is not acceptable to daisy chain cabinets together.
2. The cable shall be rated to be equal or greater than the largest supply conductor within the cabinet/rack but, it **SHALL** not be less than 6mm².
3. The tri-rated cable shall be terminated with compression lugs at each end.

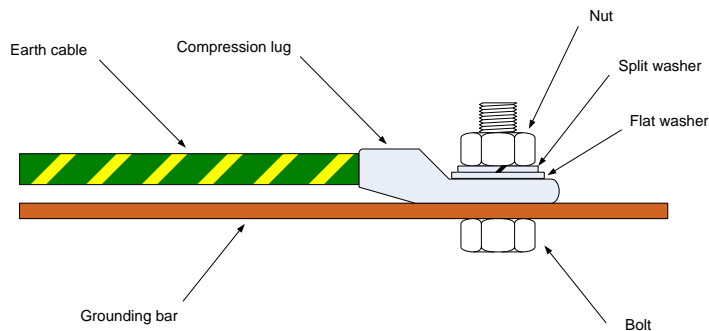

Figure 38 Detail for bonding earth cable with nut and bolt

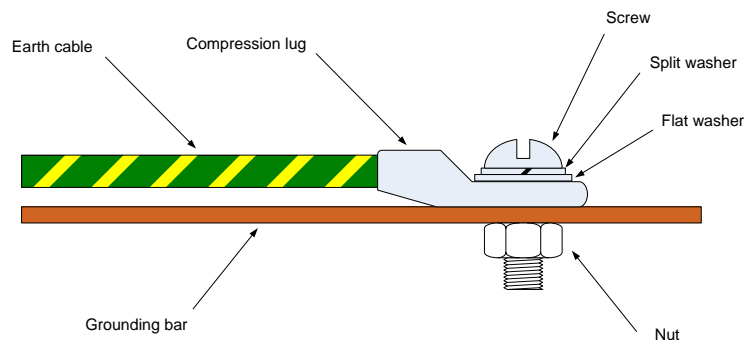

Figure 39 Detail for bonding earth cable with screw and bolt

4. A permanent tag or label printed with 'Safety Electrical Earth – Do Not Remove' shall be fitted to either end of the tri-rated cable. The label must be yellow in colour with black upper case text.



Figure 40 Earth cable label

5. A permanent label indicating the destination cabinet shall be fitted to either end of the tri-rated cable.

4.18.4 Earth Grounding Cables for Suspended Floor

1. A tri-rated cable shall be bonded to the Telecom room grounding bar to every 6 pedestals in each direction
2. The cable shall be rated to be equal or greater than the largest supply conductor within the cabinet/rack but, it **SHALL** not be less than 6mm².
3. The tri-rated cable shall be terminated with compression lugs at each end.

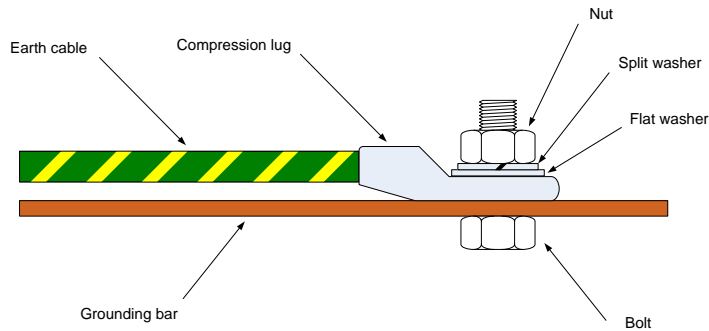

Figure 41 Detail for bonding earth cable with nut and bolt

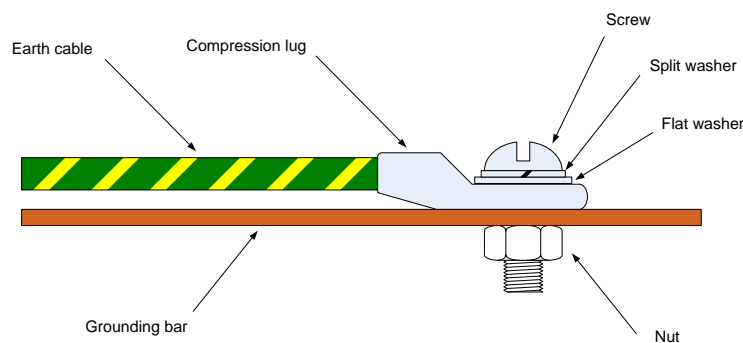

Figure 42 Detail for bonding earth cable with screw and bolt

4. A permanent tag or label printed with 'Safety Electrical Earth – Do Not Remove' shall be fitted to either end of the tri-rated cable. The label must be yellow in colour with black upper case text.



Figure 43 Earth cable label

5. A permanent label indicating the suspended floor shall be fitted to either end of the tri-rated cable.

4.18.5 Earth Grounding Cables for Patch Panels and Doors

1. A tri-rated cable shall be bonded to the cabinet grounding bar and each metallic patch panel and isolated cabinet parts i.e. doors, sides etc.
2. The cable **SHALL** not be less than 2.5mm².
3. The tri-rated cable shall be terminated with compression lugs at each end.
4. It is not acceptable to daisy chain or loop patch panels together.

4.18.6 Earth Grounding Cables for PDUs

1. A tri-rated cable shall be bonded to the cabinet grounding bar and each PDU earth lug.
2. The tri-rated cable shall be terminated with compression lugs at each end.
3. The cable cross section **SHALL** not be less than 6mm².

4.19 Security

All doors that have direct access to a telecom room shall have a suitable security lock fitted with a MUL-T-Lock M50 107X tumbler lock, which are available from the University of Southampton locksmith. These tumblers are reserved for iSolutions and available from estates and facilities.

All external windows shall be fitted with opaque glass that is obscure to level 5. Security bars shall be fitted to the inside of the windows.

4.20 Fire Detection

Each telecom room shall have a smoke and heat alarm fitted in a central ceiling location. This alarm shall be the same type and manufacture of the building fire detection system. The alarm shall be linked into the building fire detection system.

4.21 Pre-Commissioning Patch Panel Protection

Immediately after a patch panel has been installed and terminated the front of the RJ45 ports shall be protected against dust ingress. It is acceptable to use a suitable none marking tape that leaves no adhesive once removed. If the tape has to be removed for testing purposes it shall be renewed immediately after testing completion with new tape.

4.22 Telecom Room Cleaning

The Main Contractor shall clean all MER and SERs on a weekly basis. Cleaning shall cover the removal of all waste material and the vacuum cleaning of the floor and the inside of cabinets. It is not acceptable to brush the floors clean.

The cleaning shall be done from start of contract until hand over.

4.23 Frames

Within the telecommunication rooms and wiring closets, patching frames are required to house the termination of the copper distribution cabling, inter building/campus fibre optic cable and active I.T. hardware. Where the telecom room or wiring closet are shared with another provider the frames shall be fitted with doors and side panels.

Patching frames shall be:

Ortronics mighty Mo 20, with all necessary accessories and vertical cable manager enclosures for the full capacity of the hub room.

4.23.1 Frame Configuration for a MER B and SERs (2 Frames)

4.23.1.1 Sole occupancy telecom room for iSolutions

Qty	Part Number	Description 1	Units
1	MM20CMR3-W	MM20 cable mgmt ring,1.75X3",14 PCS, white	Each
2	MM20VMS704-W	MM20, vertical cable mgmt cage W/ door 4"	Each
2	MM20730-W	MM20, rack, 30" channel,7' black	Each
3	60400533	Screws, patch panel mounting, #12-24 X 0.625, 50PCS, white	Pack
1	MM20VMD716-W	MM20 vertical cable mgmt cage W/ door 16"	Each
2	OR-GBV72KIT	Vertical ground bar kit, 5/8 x 72"	Each
2	OR-60400010	Grounding kit	Each
16	OR-GL2014	Two hole ground lug	Each

4.23.1.2 Shared occupancy telecom room

Qty	Part Number	Description 1	Units
1	MM20CMR3-W	MM20 cable mgmt ring,1.75X3",14 PCS, white	Each
2	MM20VMS704-W	MM20, vertical cable mgmt cage W/ door 4"	Each
2	MM20730-W	MM20, rack, 30" channel,7' black	Each
3	60400533	Screws, patch panel mounting, #12-24 X 0.625, 50PCS, white	Pack
1	MM20VMD716-W	MM20 vertical cable mgmt cage W/ door 16"	Each
4	MM20724PD-W	MM20, perforated door, HD 24"W X 7' H, lock, white	Each
2	MM2024DMFHD-W	MM20, DR MNT FR,24" W USE W/ MM20VMD, white	Each
2	MM2024DMRHD-W	MM20,DR MNT RR,24" W USE W/O VERT MGR, white	Each
2	OR-GBV72KIT	Vertical ground bar kit, 5/8 x 72"	Each
2	OR-60400010	Grounding kit	Each
16	OR-GL2014	Two hole ground lug	Each

4.23.2 Frame Configuration for a MER A (5 Frames)

4.23.2.1 Sole occupancy telecom room for iSolutions

Qty	Part Number	Description 1	Units
2	MM20CMR3-W	MM20 cable mgmt ring,1.75X3",14 PCS, white	Each
3	MM20VMS704-W	MM20, vertical cable mgmt cage W/ door 4"	Each
5	MM20730-W	MM20, rack, 30" channel,7' black	Each
4	60400533	Screws, patch panel mounting, #12-24 X 0.625, 50PCS, white	Pack
3	MM20VMD716-W	MM20 vertical cable mgmt cage W/ door 16"	Each
4	OR-GBV72KIT	Vertical ground bar kit, 5/8 x 72"	Each
4	OR-60400010	Grounding kit	Each
32	OR-GL2014	Two hole ground lug	Each

4.23.2.2 Shared occupancy telecom room for iSolutions

Qty	Part Number	Description 1	Units
2	MM20CMR3-W	MM20 cable mgmt ring,1.75X3",14 PCS, white	Each
3	MM20VMS704-W	MM20, vertical cable mgmt cage W/ door 4"	Each
4	MM20730-W	MM20, rack, 30" channel,7' black	Each
4	60400533	Screws, patch panel mounting, #12-24 X 0.625, 50PCS, white	Pack
3	MM20VMD716-W	MM20 vertical cable mgmt cage W/ door 16"	Each
8	MM20724PD-W	MM20, perforated door, HD 24"W X 7' H, lock, white	Each
4	MM2024DMFHD-W	MM20, DR MNT FR,24" W USE W/ MM20VMD, white	Each
4	MM2024DMRHD-W	MM20,DR MNT RR,24" W USE W/O VERT MGR, white	Each
4	OR-GBV72KIT	Vertical ground bar kit, 5/8 x 72"	Each
4	OR-60400010	Grounding kit	Each
32	OR-GL2014	Two hole ground lug	Each

5 Horizontal Distribution

5.1 Overview

The horizontal distribution extends from the FD within the telecoms rooms. It is critical that the horizontal distribution design gives consideration to:

- Data communications media choice
- Layouts
- Routing
- False floor
- Ceiling void
- Cable management

5.2 Channel Design Rules

The distances quoted in Table 2 are from the source equipment (i.e. switch) to the terminal equipment (i.e. PC). Allowances shall therefore be made for vertical drops/rises as well as the horizontal runs.

Technology	Distance for application (m)			
	1000 Base T	10G Base T	1000 Base LX	10G Base LX
Cat 6	100	37	N/A	N/A
Cat 6a	100	100	N/A	N/A
OS2 Fibre	N/A	N/A	2000	10000

Table 2 - Maximum distances



Figure 44 Maximum channel design

The total length of the horizontal cable (solid conductor) shall not exceed 90m and the total length of the patch cordage (stranded cable) shall not exceed 10m. The total combined end-to-end length shall not exceed 100m and shall contain no more than 4 connectors.

5.3 Media Selection

BS 6701:2016+A1:2017 deals with telecommunications cabling and has been revised to accommodate the CPR requirements. Section 5.1.3.1 calls for a minimum classification for telecommunications cables of EuroClass Cca.

The category and type of copper cable to be installed shall be:

- For a new building – Cat 6a F/FTP Cca
- Accommodation blocks - Cat 6a F/FTP B2ca
- External to the building fabric – Cat 6 UTP
- All WiFi outlets, regardless of building type shall be Cat 6a F/FTP Cca

The grade of copper cabling shall be cat 6a. Any deviation from this document must be on written approval by iSolutions.

5.4 Patch Cord Colours and Category

Patch cord colours shall be white

All patch leads shall be category 6a shielded.

5.5 Velcro Straps

It is IMPORTANT to note that all horizontal cables and patch cords shall be secured to containment, patch panels, jacks, Minipods, bundled together etc with Velcro straps. It is not acceptable to use cable ties on any cable type.

5.6 Use Case Outlet Quantities

Each use case will demand different requirements from a structured cabling infrastructure. The main use cases and associated technologies have been defined below as the minimum requirements for outlet concentrations.

Use Case	Number of channels per outlet
University, college or school	Data and Traditional Voice
General Office	3 per user - Note 1
Temporary General Office	2 per user – Note 2
Hot Desks	2 per user
Halls of Residence	1 per room
Laboratory	1 per position
Computer room users	1 per position
Learning Space	7 per room
BMS Trend Controller	1 per controller
Automatic Metering	1 per building
RTU Power Control	1 per RTU – Note 3
Emergency Lighting	1 per building
Fire Alarm	1 per building
Door Access	1 per controller – Note 4
IP CCTV	1 per unit
Wireless AP	2 per unit – Note 5
General High Level	2 per 100m ²
Intruder Alarm Panel	1 per panel – Note 6
DECT Phone Repeater	1 per unit
Wireless Point to Point	2 per base station
Lift Controller	1 per unit – Note 7
Lift telephony	1 per lift
Barrier	To be specified by Estates

Table - Outlet Densities per use case

Notes

1. 3 ports for every 6m² shall be installed
2. 2 ports for every 6m² shall be installed
3. up to 4 controllers per building
4. up to 7 controllers per building
5. A minimum of 2 per 12m radius set on a hexagonal cell design – As per ISO/IEC 11801.
6. up to 3 panels per building
7. the controller shall be provided with a standard RJ45 feed from the nearest telecoms room and each lift shall be provided with an EVC circuit run from the data centre. The EVC is to be presented on a 237 module.

IMPORTANT – All BMS outlets, barrier and IP CCTV outlets shall be lockable and all outlets/adapters shall have clear windows.

5.7 Outlet Presentation

5.7.1 Floor Boxes

The following use cases may use the floor box design:

- General office
- PWS
- Learning space

Each floor box outlet shall consist of:

- 1 to 8 qty jacks in a 24 port Cat 6a shielded patch panel mounted in the telecom room frame/cabinet
- 1 qty printed label – patch panel
- 1 to 8 qty Cat 6a Cca F/FTP cable runs – length to be determined by Contractor
- 1 qty floor box with 1 or 2 off double gang back boxes reserved for telecoms - **shall have $\geq 50\text{mm}$ of clearance between the underside of the floor box lid and the top side of the data cables faceplate**
- 1 to 8 qty Cat 6a shielded jacks
- 1 to 8 qty straight adapter
- 1 or 3 qty blank adapter
- 1 to 8 qty engraved outlet labels and 1 qty floor box label
- 1 qty gland for floor box
- 32mm copex for cables up to floor box – length to be determined by Contractor – **the maximum number of cables per 32mm copex shall be 4 off**
- 1 qty Copex anchor – to attach the Copex to the cable basket
- Velcro type ties – suitable quantity for installation (every 300mm within the communications room and every 600mm outside of the communications room. Additional Velcro type ties shall be used as necessary)
- 2 to 18 off cable label for each Cat 6a cable run – approved type of cable label at the floor box and the patch panel

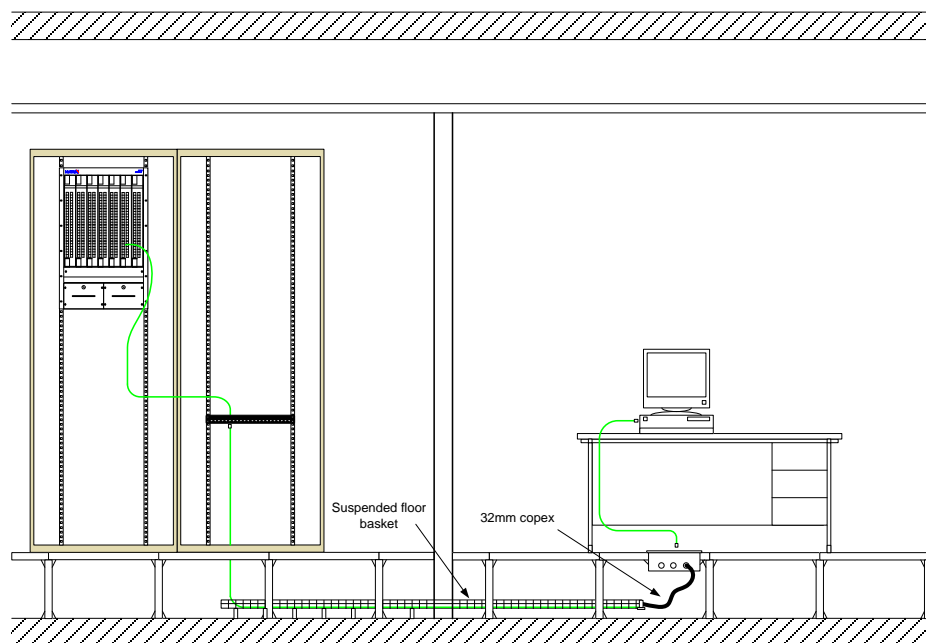

Figure 45 Floor box

5.7.2 Contractors Link

The contractors link is defined as all cabling products and containment that extend the Permanent Link (PL) from the Consolidation Point (CP) to the Telecoms Outlet (TO). The following use cases may use the floor box design:

- General office
Learning space

Each contractors link shall consist of:

- 1 to 4 qty jacks in a 24 port Cat 6a shielded patch panel mounted in the telecom room frame/cabinet
- 1 qty printed label – patch panel
- 1 to 2 qty Cat 6a F/FTP patch lead – the lead shall be measured to cater for 2 off outlets and cut in half to cater for 2 – length to be determined by Contractor
- 1 to 4 qty Cat 6a shielded jacks
- 1 to 4 qty straight adapter
- 0 to 3 qty blank adapter
- 1 to 4 qty engraved outlet labels and 1 qty floor box label
- 1 qty gland for desk box
- 1 to 4 off cable label for each Cat 6a patch lead run – approved type of cable label at the floor box indicating the outlet number

IMPORTANT – Through coupler adapters **SHALL** not be used at the desk box. If the desk comes fitted with a through coupler it shall be removed and an RJ45 with IDCs at the rear fitted.

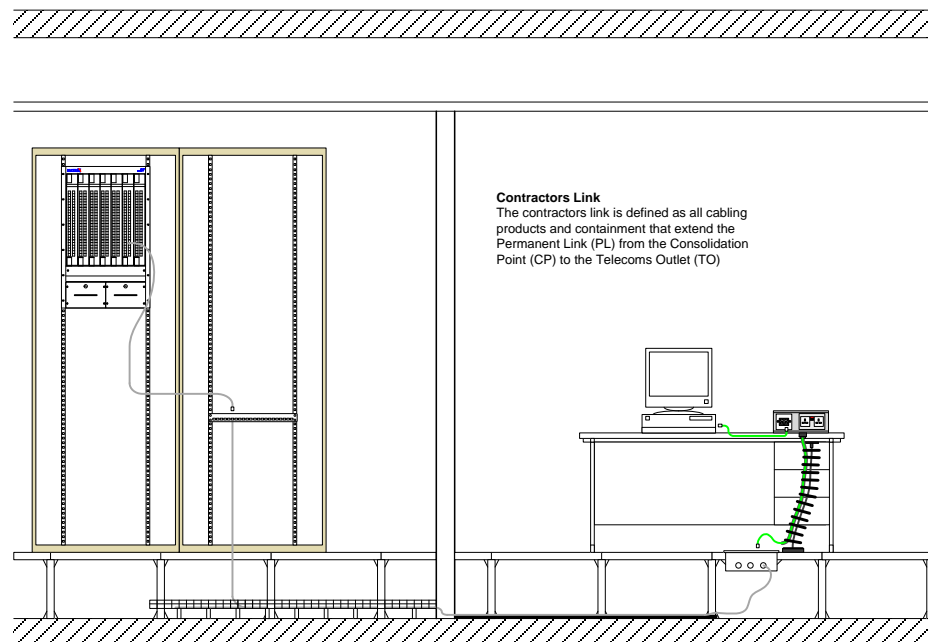

Figure 46 Contractors link

5.7.3 Under Floor Minipod

The following use cases may use the under floor box design:

- General office
- PWS
- Learning space

Each Minipod outlet shall consist of:

- 1 to 6 qty jacks in a 24 port Cat 6a shielded patch panel mounted in the telecom room frame/cabinet
- 1 qty printed label – patch panel
- 1 to 6 qty Cat 6a Cca F/FTP cable runs – length to be determined by Contractor
- 1 qty 3 or 6 way Minipod
- 1 to 6 qty Cat 6a shielded jacks
- 1 to 6 qty angled adapter
- 1 or 5 qty blank adapter
- 1 to 6 qty engraved outlet labels and 1 qty Minipod label
- 1 qty gland for Minipod
- 3m of 32mm copex for cables up to Minipod
- 1 qty Copex anchor – to attach the Copex to the cable basket
- Velcro type ties – suitable quantity for installation (every 300mm within the communications room and every 600mm outside of the communications room. Additional Velcro type ties shall be used as necessary)
- Cable label for each Cat 6a cable run – approved type of cable label at the Minipod and the patch panel

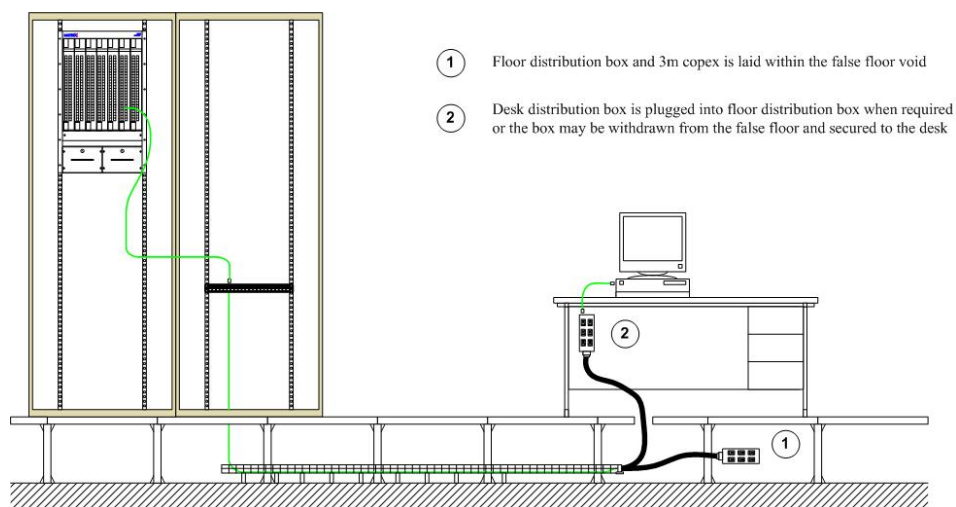

Figure 47 Under floor Minipod

5.7.4 Power pole

The following use cases may use the power pole design:

- General office
- PWS

Each Outlet shall consist of:

- 1 to 4 qty jacks in a 24 port Cat 6a shielded patch panel mounted in the telecom room frame/cabinet
- 1 qty printed label – patch panel
- 1 to 4 qty Cat 6a Cca F/FTP cable runs – length to be determined by Contractor
- 1 to 4 qty Cat 6a shielded jacks
- 1 qty single or double gang cat 6 faceplate
- 1 to 4 qty angled adapter
- 1 to 2 qty blank adapter
- 1 qty single or double back box
- 1 to 4 qty outlet label
- 1 or 2 qty gland for outlet
- Velcro type ties – suitable quantity for installation (every 300mm within the communications room and every 600mm outside of the communications room. Additional Velcro type ties shall be used as necessary)
- Cable label for each Cat 6a cable run – approved type of cable label at the CP and the TO

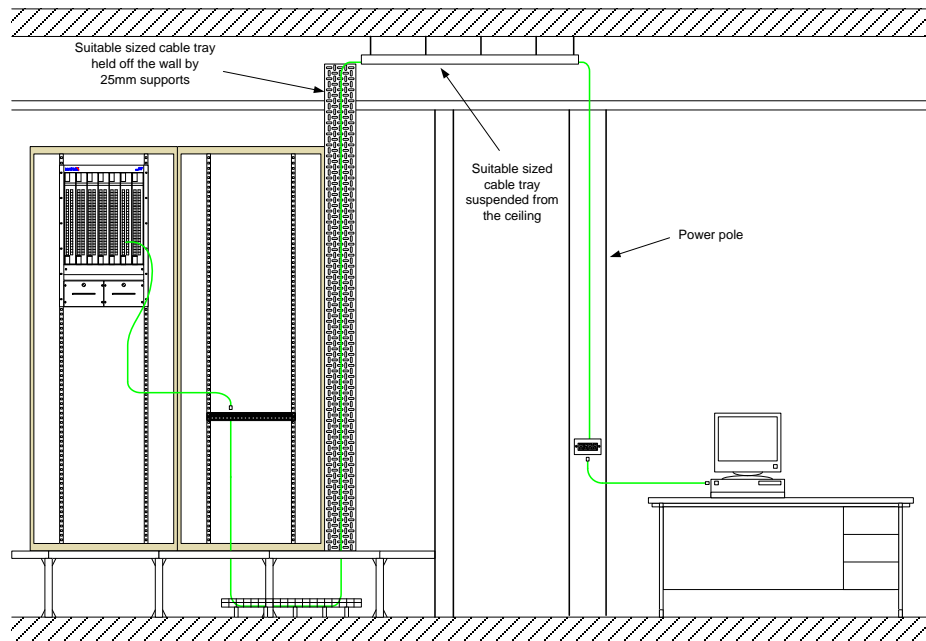

Figure 48 Power pole with consolidation point

5.7.5 Dado trunking

The following use cases may use the dado trunking design:

- General office
- Halls of residence
- PWS
- Learning space

Each dado trunking outlet shall consist of:

- 1 to 4 qty jacks in a 24 port Cat 6a shielded patch panel mounted in the telecom room frame/cabinet
- 1 qty printed label – patch panel
- 1 to 4 qty Cat 6a Cca F/FTP cable runs – length to be determined by Contractor
- 1 to 4 qty Cat 6a shielded jacks
- 1 qty single or double gang cat 6 faceplate
- 1 to 4 qty angled adapter
- 1 or 2 qty blank adapter
- 1 qty single or double gang back box
- 1 to 4 qty outlet label
- 1 or 2 qty gland for outlet
- Velcro type ties – suitable quantity for installation (every 300mm within the communications room and every 600mm outside of the communications room. Additional Velcro type ties shall be used as necessary)
- Cable label for each Cat 6a cable run – approved type of cable label at the TO and the patch panel

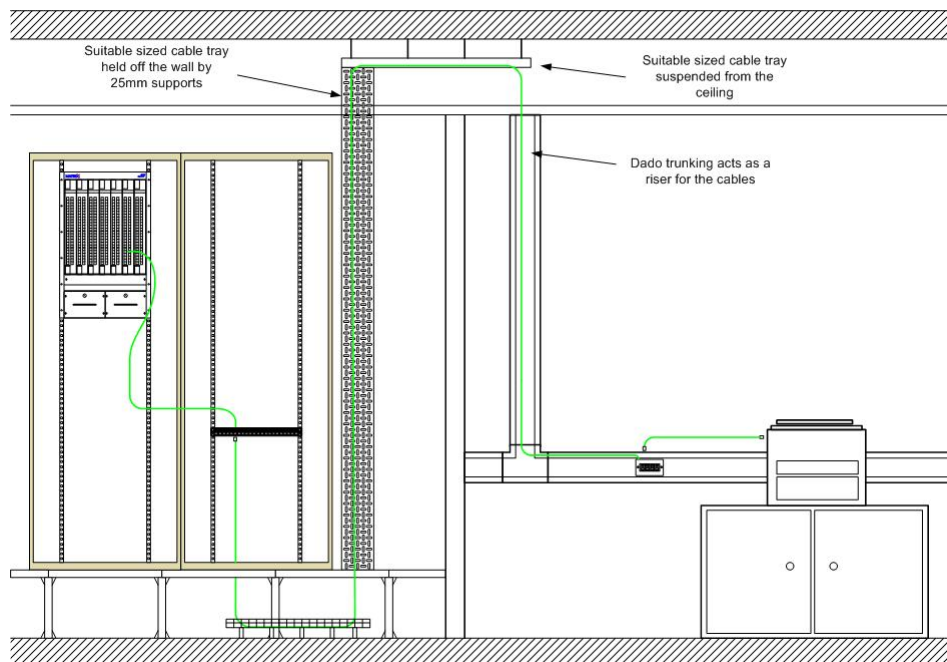

Figure 49 Dado trunking outlets

5.7.6 Stud walls

The following use cases may use the stud wall design:

- General office
- Halls of residence
- BMS Trend Controller
- Automatic Metering
- Emergency lighting
- Door access
- IP CCTV
- PWS
- RTU power
- DECT phone repeater
- Fire alarm
- Intruder alarm
- Learning Space

Each stud wall outlet shall consist of:

- 1 to 4 qty jacks in a 24 port Cat 6a shielded patch panel mounted in the telecom room frame/cabinet
- 1 qty printed label – patch panel
- 1 to 4 qty Cat 6a Cca F/FTP cable runs – length to be determined by Contractor
- 1 to 4 qty Cat 6a shielded jacks
- 1 qty single or double gang cat 6 faceplate
- 1 to 4 qty angled adapter
- 1 or 3 qty blank adapter
- 1 qty single or double gang back box
- 1 to 4 qty outlet label
- 1 qty 25mm flexible conduit – length to be determined by Contractor
- 2 qty 25mm glands
- Velcro type ties – suitable quantity for installation (every 300mm within the communications room and every 600mm outside of the communications room. Additional Velcro type ties shall be used as necessary)
- Cable label for each Cat 6a cable run – approved type of cable label at the TO and the patch panel

It is important to note that RTU power, fire alarm and intruder alarm outlets must be lockable. If the RJ45 interface to the equipment is accessible to multiple parties a lockable Cat 6a patch lead shall be used. The patch lead shall be lockable at one end only as the other end plugs into the lockable outlet.

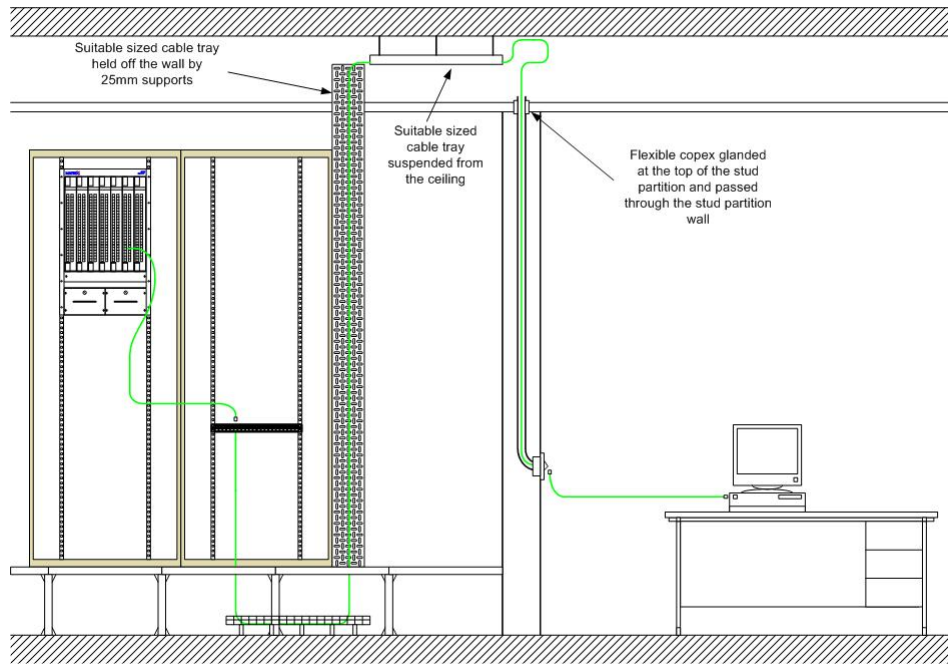

Figure 50 Stud partition outlets

5.7.7 Dry Riser

The following use cases may use the dry riser design:

- RTU power
- Door access

Each dry riser outlet shall consist of:

- 1 qty jack in a 24 port Cat 6a shielded patch panel mounted in the telecom room frame/cabinet
- 1 qty printed label – patch panel
- 1 qty Cat 6a Cca F/FTP cable runs – length to be determined by Contractor
- 1 qty Cat 6a shielded jack
- 1 qty single gang cat 6 faceplate
- 1 qty angled adapter
- 1 blank adapter
- 1 qty single gang back box
- 1 qty outlet label
- 1 qty gland for outlet
- Velcro type ties – suitable quantity for installation (every 300mm within the communications room and every 600mm outside of the communications room. Additional Velcro type ties shall be used as necessary)
- Cable label for each Cat 6a cable run – approved type of cable label at the TO and the patch panel

The outlet shall be within 1m of the control unit and within 150mm of the containment.

If the RJ45 interface to the equipment is accessible to multiple parties a lockable Cat 6a patch lead shall be used. The patch lead shall be lockable at one end only as the other end plugs into the lockable outlet.

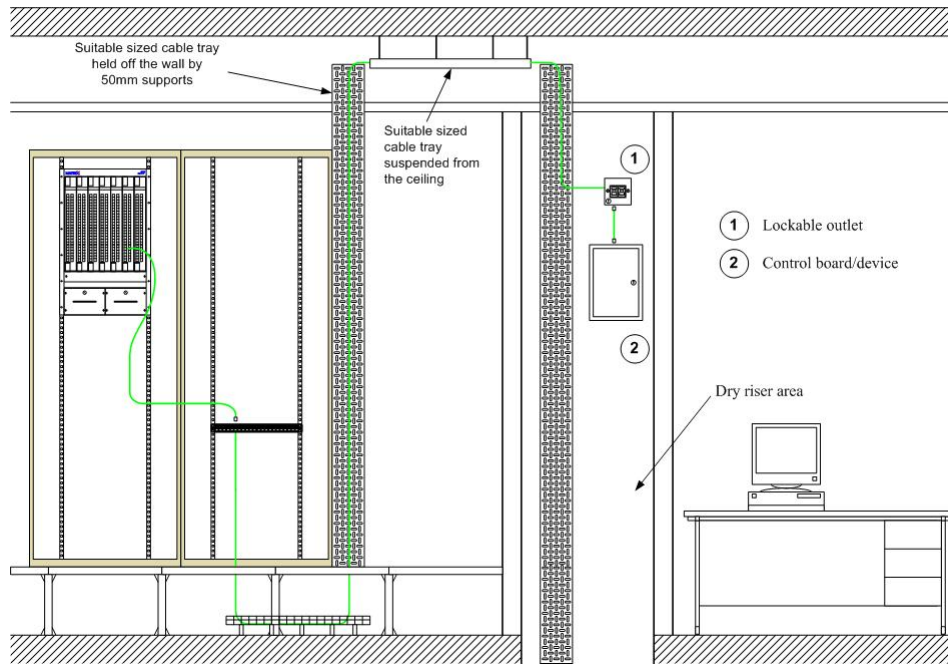

Figure 51 Dry Riser Outlets

5.7.8 Suspended Ceiling

The following use cases may use the suspended ceiling design:

- IP CCTV
- Wireless AP
- General high level
- DECT phone repeater

Each outlet shall consist of:

- 2 qty jacks in a 24 port Cat 6a shielded patch panel mounted in the telecom room frame/cabinet
- 1 qty printed label – patch panel
- 2 qty Cat 6a Cca F/FTP cable runs – length to be determined by Contractor
- 2 qty Cat 6a shielded jacks
- 1 qty 5m loop of cable from the containment run. The two cables for the AP shall be strapped together with Velcro straps every 300mm
- 1 qty single gang Cat 6a faceplate
- 2 qty straight adapter
- 1 qty single gang back box
- 2 qty outlet label
- 1 qty gland for outlet
- Velcro type ties – suitable quantity for installation (every 300mm within the communications room and every 600mm outside of the communications room. Additional Velcro type ties shall be used as necessary)
- Cable label for each Cat 6a cable run – approved type of cable label at the CP and the patch panel

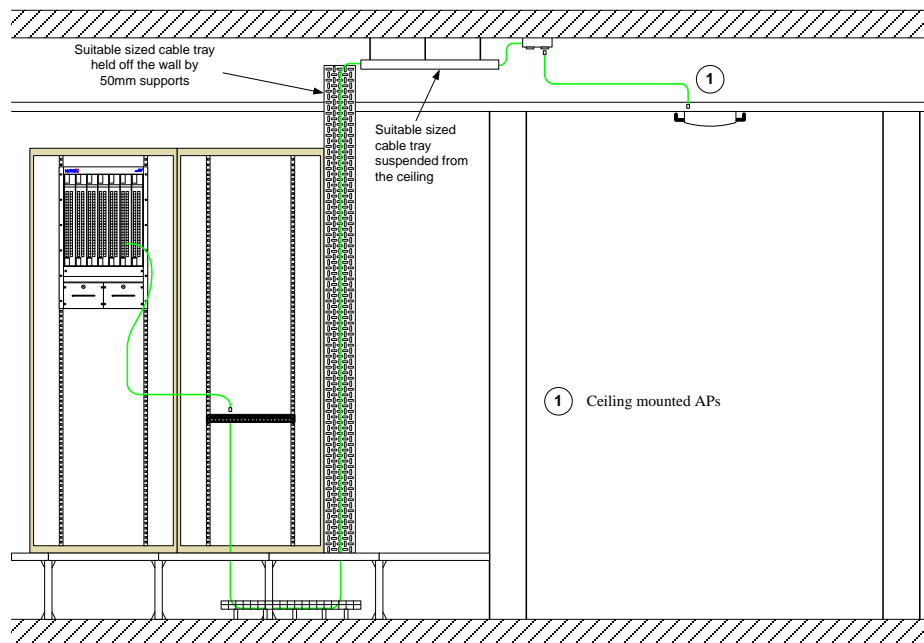

Figure 52 Suspended ceiling outlets

5.7.9 Ceiling Mounted – No Suspended Ceiling

The following use cases may use the ceiling mounted design:

- IP CCTV
- Wireless AP
- DECT phone repeater

Each outlet shall consist of:

- 1 qty mounting bracket. The bracket shall be long enough to suspend the AP below all M&E services
- 1 qty 24 port cat 6a shielded patch panel mounted in the data room frame/cabinet
- 1 qty printed label – patch panel
- 1 qty cat 6a Cca F/FTP cable runs – length to be determined by Contractor
- 1 qty cat 6a shielded jacks
- 1 qty single gang lockable faceplate
- 1 qty straight adapter
- 1 qty blank adapter
- 1 qty single gang back box
- 1 qty outlet label
- 1 qty gland for outlet
- Velcro type ties – suitable quantity for installation (every 300mm within the communications room and every 600mm outside of the communications room. Additional Velcro type ties shall be used as necessary)
- Cable label for each cat 6a cable run – approved type of cable label at the TO and the patch panel

The outlet must be within 100mm of the AP mounting bracket.

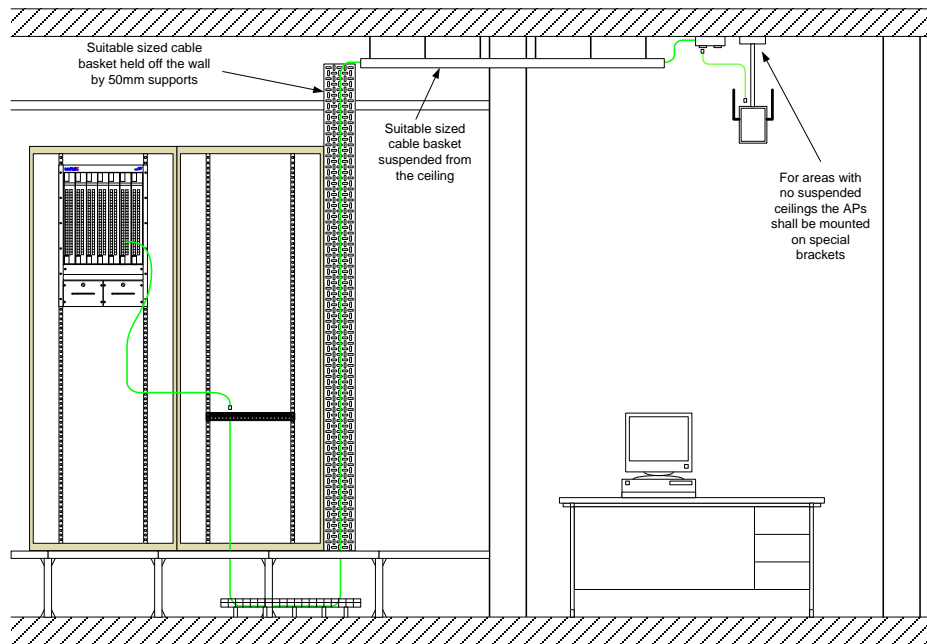

Figure 53 Ceiling mounted with no suspended ceiling outlets

5.7.10 Surface Mounted

The following use cases may use the surface mounted design:

- Halls of Residence
- BMS Trend Controller
- Automatic Metering
- RTU power
- Emergency lighting
- Door access
- IP CCTV
- Wireless AP
- DECT phone repeater
- Fire alarm
- Lift controller
- Lift telephony
- Door access

Each surface mounted outlet shall consist of:

- 1 to 4 qty jacks in a 24 port Cat 6a shielded patch panel mounted in the telecom room frame/cabinet
- 1 qty printed label – patch panel
- 1 to 4 qty Cat 6a Cca F/FTP cable runs – length to be determined by Contractor
- 1 to 4 qty Cat 6a shielded jacks
- 1 qty single or double gang lockable Cat 6a faceplate
- 1 to 4 qty angled adapter
- 1 to 2 qty blank adapter
- 1 qty single or double gang back box
- 2 to 4 qty outlet label
- 1 qty gland for outlet

- Velcro type ties – suitable quantity for installation (every 300mm within the communications room and every 600mm outside of the communications room. Additional Velcro type ties shall be used as necessary)
- Cable label for each Cat 6a cable run – approved type of cable label at the TO and the patch panel

As the outlets are exposed to multiple parties a lockable Cat 6a patch lead shall be used. The patch lead shall be lockable at one end only as the other end plugs into the lockable outlet.

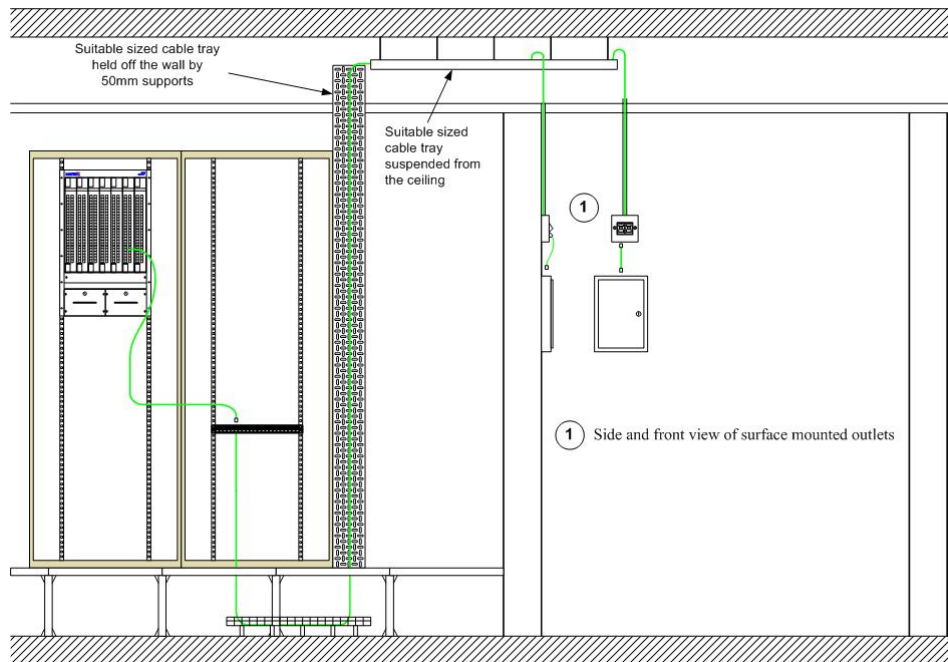

Figure 54 Surface mounted outlets

5.7.11 Temporary Outlets

The following use cases may use the temporary outlet design:

- Temporary General Office

For temporary desk locations the preferred option is to use Consolidation Points (CP) in the ceiling which drop down to trunking or mini trunking outlets. Each CP shall be sized according to the requirements of the temporary desks and may consist of single, double, quad outlets as well as 3, 4 or 6 port minipods.

The cable from the Consolidation Point (CP) to the TO shall be of a solid conductor construction i.e. horizontal cable and not patch cordage.

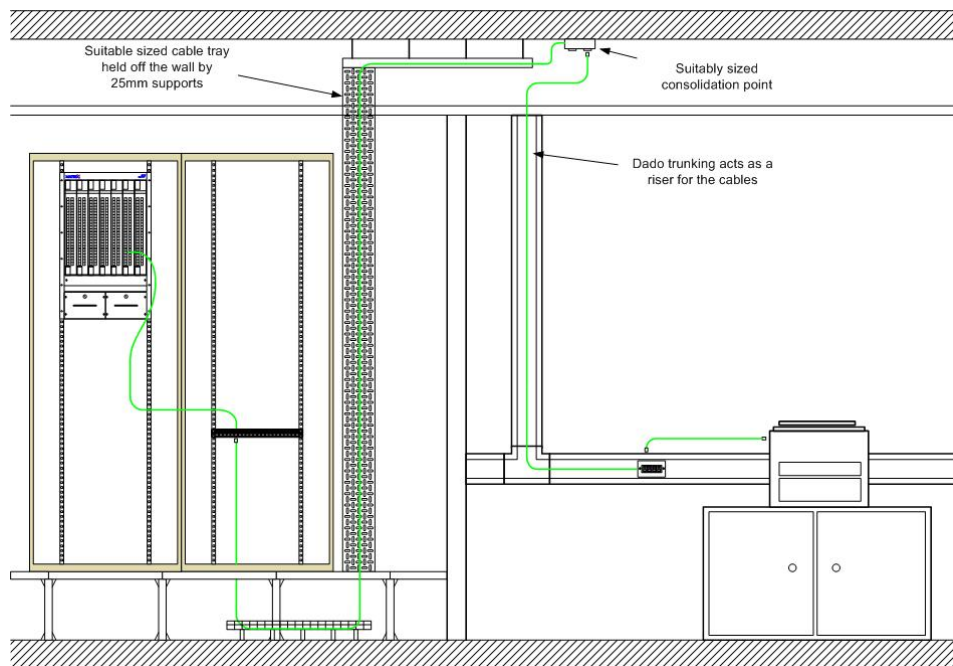

Figure 55 Temporary outlet with consolidation point

5.7.12 External

The following use cases may use the external design:

- Wireless point to point

Each external outlet shall consist of:

- 1 qty jack in a 24 port cat 6 UTP patch panel mounted in the telecom room frame/cabinet
- 1 qty printed label – patch panel
- 1 qty cat 6 external rated UTP cable runs – length to be determined by Contractor
- 1 qty cat 6 UTP jack
- 1 qty external IP 67/65 rated wall box
- 1 qty straight adapter
- 1 qty blank adapter
- 1 qty outlet label
- 1 qty gland for outlet
- Velcro type ties – suitable quantity for installation (every 300mm within the communications room and every 600mm outside of the communications room. Additional Velcro type ties shall be used as necessary)
- Cable label for each cat 6 cable run – approved type of cable label at the TO and the patch panel

All external copper cable runs shall be protected with a lightning surge protection device rated at 1G Base Tx. The device shall be located within 2 metres of the building entrance and be suitably bonded to earth.

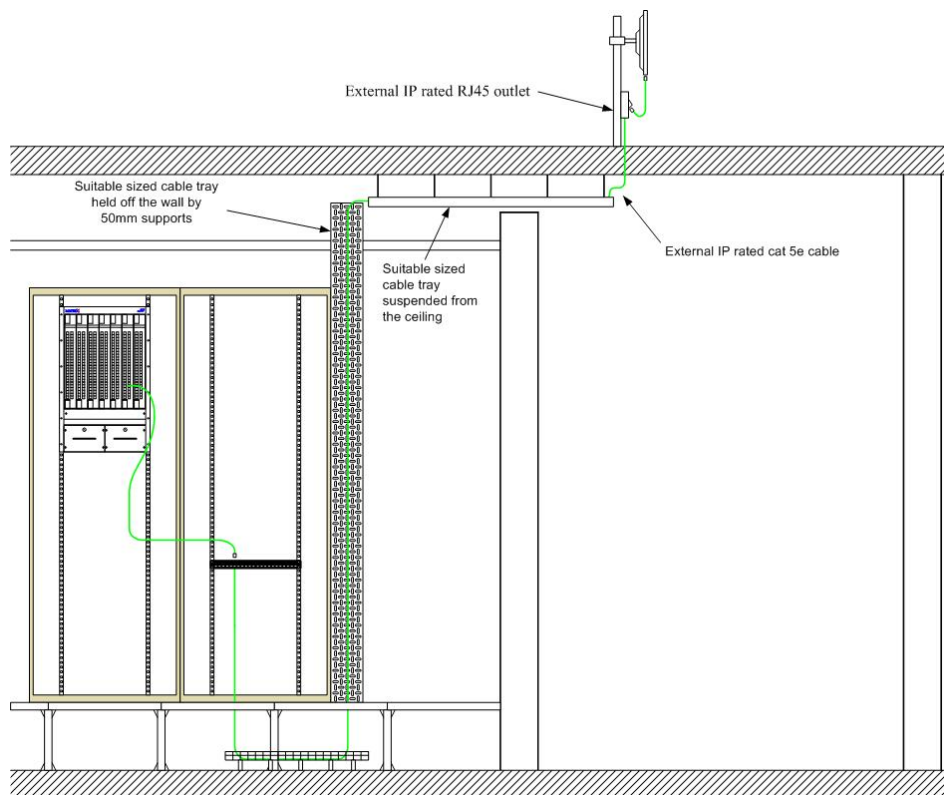

Figure 56 External mounted outlets

5.7.13 External APs

The following use cases may use the external design:

- Wireless APs

Each external outlet shall consist of:

- 1 to 4 qty jacks in a 24 port Cat 6a shielded patch panel mounted in the telecom room frame/cabinet
- 1 qty printed label – patch panel
- 1 to 4 qty Cat 6a Cca F/FTP cable runs – length to be determined by Contractor
- 1 to 4 qty Cat 6a shielded jacks
- 1 qty single or double gang Cat 6a faceplate
- 1 to 4 qty angled adapter
- 1 to 2 qty blank adapter
- 1 qty single or double gang back box
- 2 to 4 qty outlet label
- 1 qty gland for outlet
- Velcro type ties – suitable quantity for installation (every 300mm within the communications room and every 600mm outside of the communications room. Additional Velcro type ties shall be used as necessary)
- Cable label for each Cat 6a cable run – approved type of cable label at the TO and the patch panel

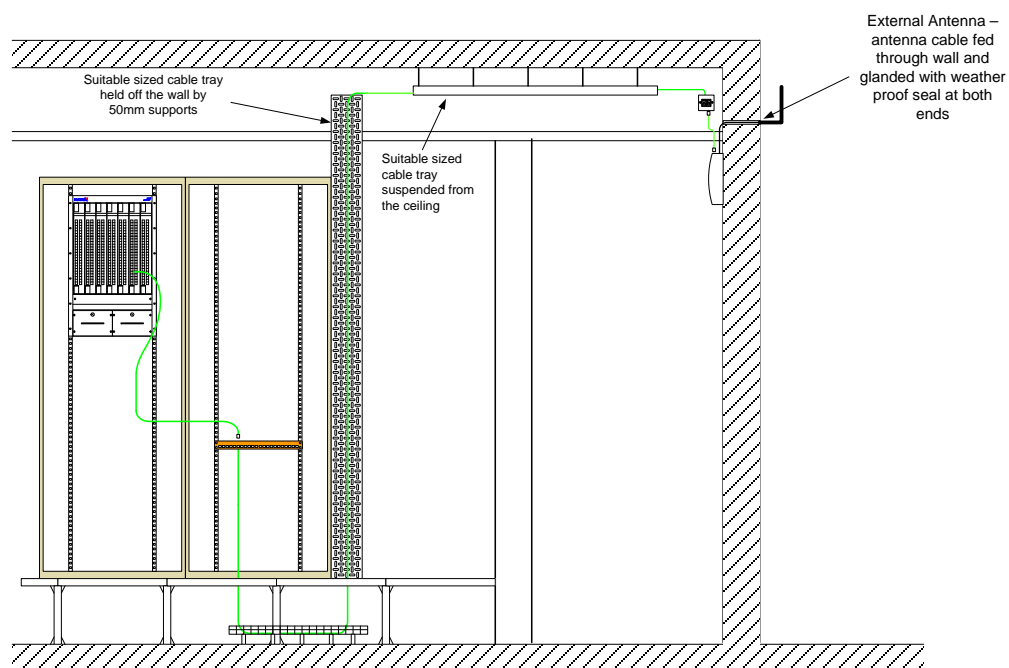

Figure 57 External mounted wireless APs

5.7.14 Remote external APs with Powered Fibre Cable

The following use cases may use the external design:

- Wireless APs that are remote from buildings or buildings with no telecom rooms.

- IP CCTV cameras that are remote from buildings or buildings with no telecom rooms

Each external outlet shall consist of:

- 1 or 2 qty duplex LC OS2 connector in a 48 core OS2 LC patch panel mounted in the telecom room frame/cabinet
- 2 or 4 qty OS2 LC pigtailed
- 1 qty printed label – patch panel
- 1 qty CommScope 12 awg 2 or 4 core OS2 hybrid powered fibre cable run – length to be determined by Contractor
- 1 qty 1 or 2 port CommScope PoE extender
- 1 qty printed label – PoE extender
- 1 qty duplex patch cord cut in half – this is to be spliced onto the powered fibre cable at the CommScope PoE extender for connection into the SFP
- 1 qty SPF 1G port single mode transceiver module
- 1 qty port in a 19” rack mounted -48V dc power supply – CommScope Power Express Class 2 with alarm module
- 1 to 4 qty Power Express distribution module – max 8 devices
- 1 to 3 qty Power Express blank slot panel
- 1 qty port in a 19” rack mounted -rectifier – CommScope SPS rectifier distribution shelf
- 1 qty rectifier controller display
- 1 to 3 qty SPS power rectifier module – 1600W per module
- 0 to 2 qty rectifier blank slot panel
- 2 qty 2 or 4 AWG bus bar power conductors plus lugs at each end – to connect the Power Express Class 2 shelf with the SPS power rectifier distribution shelf
- Velcro type ties – suitable quantity for installation (every 300mm within the communications room and every 600mm outside of the communications room. Additional Velcro type ties shall be used as necessary)
- Cable label for each powered fibre cable run – approved type of cable label at the TO and the patch panel

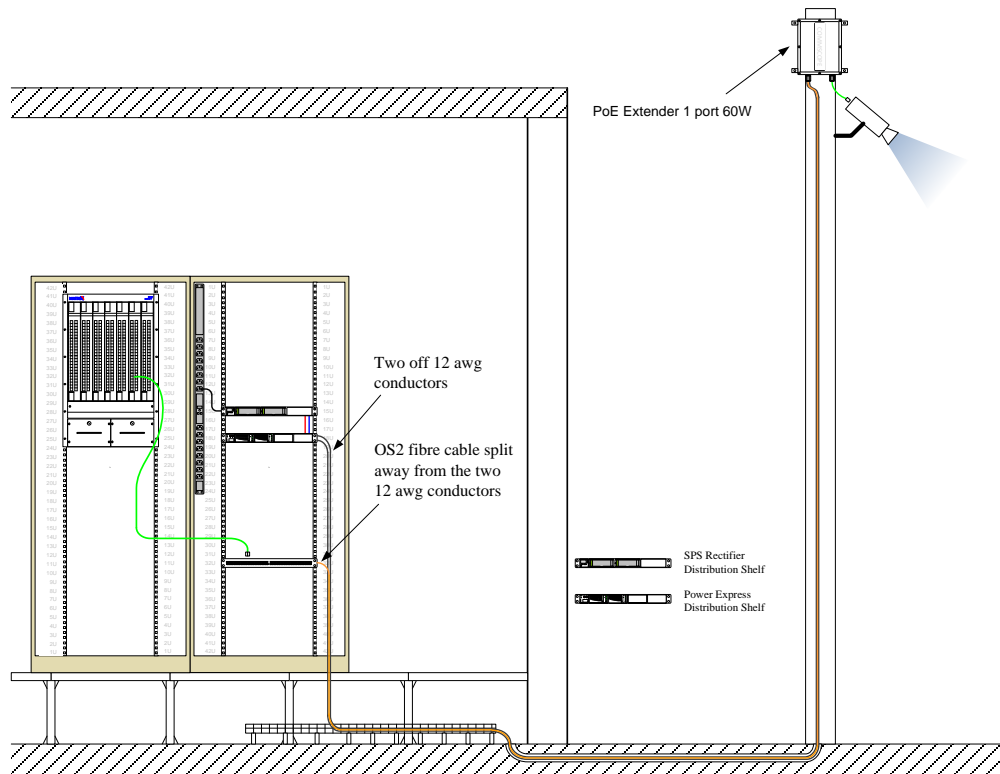

Figure 58 Powered fibre cable

5.8 Barrier Systems for Vehicles

Barrier systems will require some form of data/voice communication but due to the uncertain nature of these requirements barrier systems shall be specified on a case by case basis. The Contractor shall seek approval in writing from the University for the specification of the barrier system, communications and position.

5.9 Cable Management

All cabling within the telecom rooms shall be bundled together in no more than 24 cables. This shall include horizontal, vertical and cabinet containment. All cabling outside of the telecom room shall be loose laid.

The capacity of cables must cater for requirements that will be implemented from day one and all known requirements that will follow in the future plus a 25% additional capacity for unknown future expansion.

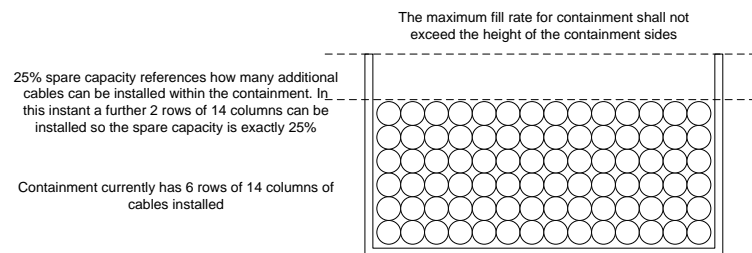

Figure 59 Example of 25% spare capacity

Cable management is split between cable basket loose laid and bundled (all cabling within the telecom room shall be bundled) and trunking loose laid. This is primarily to cater for the differing requirements for capacity and future expansion requirements.

5.9.1 Trunking Loose Laid

Trunking for the use of telecommunication services should be dedicated to telecommunication services only. Where multi-compartment trunking is used the telecom services compartment shall not be shared with other services. When using triple compartment dado trunking, all communication cabling shall only use the top and bottom sections of trunking.

When calculating the capacity of trunking it shall have at least 25% future capacity. Allow 7.1mm for the overall diameter of a category 6a cable.

Example 1 – a 65 x 70 piece of trunking

$$\begin{aligned} \text{Area of one cable} &= \left(\frac{(\text{cable diameter}^2) \times 3.14}{4} \right) \\ &= \left(\frac{(7.1^2) \times 3.14}{4} \right) \\ &= 39.57\text{mm}^2 \end{aligned}$$

$$\begin{aligned} \text{Useable area of trunking} &= (\text{width} \times \text{depth}) \times 0.75 \\ &= (70 \times 65) \times 0.75 \\ &= 3413\text{mm} \end{aligned}$$

$$\text{Number of cables} = \left(\frac{\text{useable area of containment}}{\text{area of one cable} / 0.7854} \right)$$

$$= \left(\frac{3413}{39.57/0.7854} \right)$$

$$= 67$$

For standard trunking sizes the below table details the maximum cable capacity. These are calculated for category 6a cables and should be applied for category 6 cables i.e. if 4 category 6 cables are to be installed in mini trunking it shall be sized to cater for 4 category 6a cables. When using mini trunking there is no consideration for future capacity i.e. it is allowable to 100% fill during the initial installation. The only exception to this rule is if there is a known future requirement for further cables to be installed in which case the trunking size shall be selected to cater for the future requirements.

The minimum size of mini trunking shall be 40 x 25mm.

Size	Trade Ref.	No. Cat 6a Cables
40 x 25	YT4	4

Table 5 Standard Trunking Capacity

5.9.2 Cable Basket

Cable basket for the use of telecommunication services shall be dedicated to telecommunication services only. The cable basket shall not be shared with other services. Where it is not possible to have separate containment systems for power and data cables the single containment system shall provide the correct power separation distance by using two parallel rows of metallic fillets. The two rows of fillets shall be spaced according to section 4.16 above.

When calculating the capacity of cable basket, it shall have at least 25% future capacity. All cable baskets shall be calculated to cater for category 6a cable. The maximum depth of cables on a cable basket is 100mm. Allow 7.1mm for the overall diameter of a category 6a cable.

Cables in the following areas shall be in bundles of no more than 24 and tied together with Velcro straps every 300mm:

- Horizontal containment within telecom rooms
- Vertical containment within telecom rooms
- Vertical risers outside of telecom rooms
- From entering cabinets to the rear of the patch panel
- All areas that are visible to the naked eye outside of telecom rooms (relaxed to 400mm)

All cables outside the telecom rooms shall be loose laid. All cables inside the telecom rooms shall be bundled.

5.9.2.1 Cable basket Bundled

Example 1 – a 400 x 100mm cable basket

Area of one cable = $\left(\frac{(cable\ diameter)^2 \times 3.14}{4} \right)$

$$= \left(\frac{(7.1^2) \times 3.14}{4} \right)$$

$$= 39.57\text{mm}^2$$

Useable area of basket = (width x depth) x 0.75

$$= (400 \times 100) \times 0.75$$

$$= 30000\text{mm}$$

Number of cables = $\left(\frac{\text{useable area of containment}}{\text{area of one cable} \times 2} \right)$

$$= \left(\frac{30000}{39.57 \times 2} \right)$$

$$= 379$$

5.9.2.2 Cable Basket Loose Laid

Example 1 – a 400 x 100mm cable basket

Area of one cable = $\left(\frac{(\text{cable diameter}^2) \times 3.14}{4} \right)$

$$= \left(\frac{(7.1^2) \times 3.14}{4} \right)$$

$$= 39.57\text{mm}^2$$

Useable area of basket = (width x depth) x 0.75

$$= (400 \times 100) \times 0.75$$

$$= 30000\text{mm}$$

Number of cables = $\left(\frac{\text{useable area of containment}}{\text{area of one cable}/0.7854} \right)$

$$= \left(\frac{30000}{39.57/0.7854} \right)$$

$$= 595$$

5.10 Cable Capacity

Planning of cable capacity shall be co-ordinated with all parties involved in the planning, design and implementation of the IT network. The capacity of cables shall cater for requirements that will be implemented from day one and all known requirements that will follow in the future plus a 25% additional capacity for unknown future expansion.

5.11 Horizontal Cable Basket and Trunking

5.11.1 General Rules for Containment

The general rules for all high and low level horizontal data and telecom containment are:

- Cables shall not exceed 150mm in depth. If this cannot be achieved, then special dispensation shall be sought from NWI. If NWI agree that the cable depth can be increased above 150mm then 8mm fire retardant (LPS1207) flooring sheets shall be installed in the bottom of the cable basket

- i. *EN 50174-2 – Requirements – Section 4.4.1.3 – ‘The maximum stacking height in pathway systems is specified by manufacturers’ instructions. If instructions do not exist, the following shall apply:*
 - *1) for pathway systems that provide continuous support (e.g. trays), the stacking height shall not exceed 150 mm’*
- All cables to be installed in bundles of 24 cables. This shall only apply within the telecom rooms.
 - i. *EN 50174-2 – Requirements – Section 5.3.5.3.1 – ‘Bundles of cables shall not contain more than 24 cables’*
- The cables shall be tram lined and shall not cross over. This shall only apply within the telecom rooms.
- All cable bundles of 24 shall be tied with Velcros at 300mm centres
 - i. *Requirements for bundled cables only*
- Shall not be shared with other services i.e. mains, fire detection, BMS etc. shall be on its own cable basket and the copper shall be on its own cable basket for its entire length
 - i. *EN 50174-2 – Requirements – Section 6 – Details all requirements for separation distances and none sharing of services*

‘Power supply cables and cables of other “trades” shall not be installed within the same bundle or in the same compartment of a pathway or pathway system, as information technology cables unless physical separation is maintained.’
- Copper and fibre data cables/tubing shall not share the same containment i.e. the fibre cabling shall be on its own cable basket and the copper shall be on its own cable basket for its entire length
- Trunking may share services, but it shall be multi compartment and the data/telecom cables shall not share services within their compartment
 - i. *EN 50174-2 – Requirements – Section 6 – Details all requirements for separation distances and none sharing of services*

‘Power supply cables and cables of other “trades” shall not be installed within the same bundle or in the same compartment of a pathway or pathway system, as information technology cables unless physical separation is maintained.’
- Shall not be used as a support for other systems i.e. strapping cables to outside of the containment, structural support for lighting pendants etc.
 - i. *EN 50174-1 – Requirements – Section 4.3.2.1 – ‘Elements of other supply systems such as water, heating, HVAC or sprinklers shall not be used as pathways or support for pathway systems due to the potential environmental impact on the cabling components and the risk that cable support will disappear following changes made to the supporting system.’*
- Data/telecom cables shall not be supported by any other Mechanical and Electrical fittings/supports. It is not acceptable to strap cables to HVAC ducting, BMS, cables, ceiling tile supports etc.

EN 50174-1 – Requirements – Section 4.3.2.1 – ‘Elements of other supply systems such as water, heating, HVAC or sprinklers shall not be used as pathways or support for pathway systems due to the potential environmental impact on the cabling components and the risk that cable support will disappear following changes made to the supporting system.’

NOTE An exception to this is where the telecommunications cabling directly serves a device of the supply system (e.g. water meter).

The grids of suspended ceilings shall not be used as support for pathway systems but may be used as pathways for individual cables serving devices within the suspended ceiling.'

- Cables shall not be stacked above the height of the cable basket side walls i.e. if the cable basket has side walls of 100mm then the cable depth shall not exceed 100mm
 - i. *General requirements*
- All cable baskets and metal trunking shall be earth bonded to BS 7671
 - i. *EN 50174-1 – Requirements – Section 5.3.3.2 – ‘Where an electrically conductive cable management system is installed, sections shall be bonded to earth in accordance with 5.1.1.1 in order that the cable management system acts as a PEC described in 7.1.3.4.’*
 - ii. *EN 50174-1 – Requirements – Section 5.3.3.3.1 – ‘The following requirements apply to metallic or composite cable management systems that are required specifically to provide electromagnetic screening for the information technology cables to be contained within them (see 4.4.1): a) if the cable management system is constructed from multiple sections: – the sections shall be interconnected to ensure continuity; – bonds shall have performance in accordance with EN 50310 (illustrated in Figures 6 b) and 6 c)); b) cable management systems shall be functionally bonded in accordance with EN 50310;’*
- There shall be no discontinuation between sections of cable basket or trunking unless compliant with BS 7671 i.e. earth bond 4mm² connecting containment systems
 - *EN 50174-2 – Requirements – Section 5.3.3.3.1.*

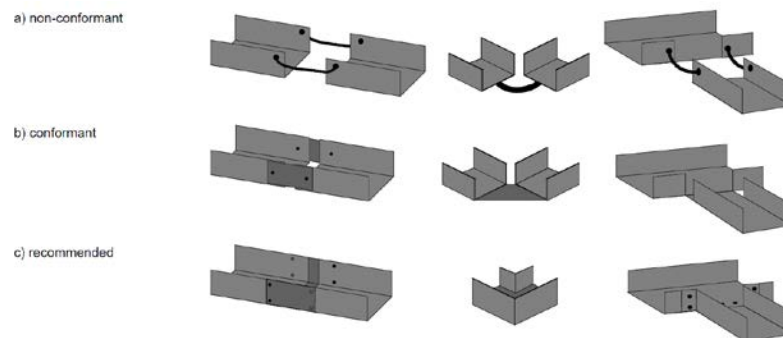

- All cable baskets and trunking shall be jointed together with the manufacturer's fixings
 - i. *General requirements*
- All sections of containment, bends, joints, clamps, bonding etc. shall be from a single Manufacturer. It is not acceptable to mix and match containment products from different Manufacturers
 - i. *General requirements*
- Cable containment shall have manufactured bends – it is not acceptable to change direction by butting together two sections with no manufactured bend
 - i. *General requirements. Not applicable for cable basket*
- Cable basket external and internal bends shall be $\geq 200\text{mm}$ radius
 - i. *This is to cater for blown fibre*

- Cable basket right angle bends shall be $\geq 200\text{mm}$ radius
 - i. This is to cater for blown fibre*
- Cables entering a riser at low level shall immediately enter a wall mounted cable basket riser
 - Vertical cable basket supported by 41mm Unistrut bars
 - i. EN 50174-1 – Requirements – Section 4.3.2.1 - Pathways constructed using tray-work shall be located to:*
 - provide a minimum clearance of 25 mm from the fixing surface;*
 - provide the greatest working space possible subject to a minimum of 150 mm above the tray to enable access during installation;*
 - Vertical Unistrut bars to be spaced at 1000mm centres
 - Lowest Unistrut bar to be within 50mm of the cable basket end
 - Highest Unistrut bar to be within 50mm of radius to horizontal cable basket
 - There shall be a cable basket with a radius of $\geq 200\text{mm}$ between the vertical and horizontal cable basket
- Where cables penetrate walls or fire barriers the containment shall penetrate completely through
 - i. EN 50174-2 – Requirements – Section 5.3.3.3.1. – ‘Figure 7 shows cable management systems crossing a wall at which a fire barrier is to be installed following cable installation. Unless specifically allowed by local regulations, the fire-stop materials or fire-stopping techniques, the cable management system shall be interrupted (with the smallest gap consistent with the construction of the fire barrier and allowing for the thermal expansion of the cable management system) and the two metallic sections shall be bonded. The bonds shall have performance in accordance with EN 50310;’*
 - ii. Existing requirement*
- Fire barriers shall be sealed to the fire rating of the penetrated barrier
 - i. EN 50174-2 – Requirements – Section 10.3.3.1.1 – ‘Any openings created within the building fabric by the planning of the selected pathways and pathway systems shall: 1) not cause damage to adjacent properties without prior permission; 2) be treated to maintain the mechanical strength, fire protection, thermal insulation and sound insulation of the premises;’*
 - ii. Existing requirement*
- Where cable baskets cross power cables they shall be bridged at 90° .
 - i. EN 50174-2 – Requirements – Section 6.2.1 – ‘The minimum separation requirement applies in three dimensions. However, where Information technology cables and power supply cables are required to cross and required minimum separation cannot be maintained then the angle of their crossing shall be maintained at 90 degrees on either side of the crossing for a distance no less than the applicable minimum separation requirement.’*
- **Where there are multiple tiers of cable baskets the most accessible position shall be reserved for data cable basket i.e. for suspended floors the data cabling basket shall be the top most and for suspended ceilings it shall be the bottom most**
- The cable basket shall be labelled at $\leq 1800\text{mm}$ centres with a Traffolyte engraved label of dimensions ≥ 150 (length) x 50 (height) x 1.6mm (depth). The label shall be tied on at both ends of the label. The label shall be yellow with black lettering. The text shall read ‘IT COPPER Data Cabling ONLY’ or ‘IT FIBRE Data Cabling ONLY’.

- i. *EN 50174-1 – Requirements – Section 4.5.2 – ‘An administration system shall be specified to enable effective operation, maintenance and repair of the cabling infrastructure. All information produced for or by the administration system shall be dated. Change control shall be exercised and records shall be retained for a specified minimum period.*
- Tight/unnecessary bends in trunking/basket shall be avoided.
- i. *EN 50174-2 – Requirements – Section 4.4.1.2 – ‘Minimum bend radius is specified by manufacturers’ instructions. If instructions do not exist, the minimum bend radius shall be the greater of either 50 mm or:*
 - 1) *4 x the cable diameter for 4-pair balanced cables;*
 - 2) *8 x the cable diameter for other metallic cables;*
 - 3) *10 x the cable diameter for optical fibre cables;*
 - 4) *10 x the cable diameter for coaxial cables,’*
- Minimum cable bend radius to be adhered to at all times
 - i. *EN 50174-2 – Requirements – Section 4.4.1.2 – ‘Minimum bend radius is specified by manufacturers’ instructions. If instructions do not exist, the minimum bend radius shall be the greater of either 50 mm or:*
 - 1) *4 x the cable diameter for 4-pair balanced cables;*
 - 2) *8 x the cable diameter for other metallic cables;*
 - 3) *10 x the cable diameter for optical fibre cables;*
 - 4) *10 x the cable diameter for coaxial cables,’*
 - ii. *Where cables are dressed loose laid or are dressed into position and then bundled with cable straps the above requirements (i) shall apply to the dia of a single cable. Where cables are bundled together with cable straps and then dressed into position the above requirements (i) shall apply to the dia of the overall bundle.*
- Draw wires to be installed in all empty conduits $\geq 50\text{mm ID}$.
- Changes in cable containment i.e. basket to riser ladder, basket to conduit or copex etc. shall be within 200mm of each other
- Changes in cable containment from vertical to horizontal and vice versa shall be within 200mm of each other
- The Unistrut bar shall be fully de-burred with end caps installed as required
 - EN 50174-1 – Requirements – Section 4.3.2.1 – ‘The pathway systems shall:*
 - have smooth surfaces and be free of burrs, sharp edges or projections that can damage the cables;*
 - be free of pressure points that may degrade the transmission performance of the installed system.’*
- Cable baskets shall not be installed upside down or flat against a wall. The only exception is vertical risers.
 - i. *BS 7671:2018 (IET Wiring Regulations Eighteenth Edition), which was published in January 2018 and comes into effect on 1 January 2019, will include a requirement that wiring systems all locations. The requirement is included in a new regulation (Regulation 521.10.202), which is reproduced below.*
 - 521.10.202** *Wiring systems shall be supported such that they will not be liable to premature collapse in the event of a fire.*

NOTE 1: Wiring systems hanging across access or egress routes may hinder evacuation and firefighting activities.

NOTE 2: Cables installed in or on steel cable containment systems are deemed to meet the requirements of this regulation.

NOTE 3: This regulation precludes, for example, the use of non-metallic cable clips or cable ties as the sole means of support where cables are clipped direct to exposed surfaces or suspended under cable tray, and the use of non-metallic cable trunking as the sole means of support of the cables therein.

NOTE 4: Suitably spaced steel or copper clips, saddles or ties are examples that will meet the requirements of this regulation.

- Cable baskets can be mounted with the base of the basket against walls but only where they form a riser i.e. vertically
- Cable baskets mounted on walls in a horizontal aspect shall be mounted on wall brackets that keeps the base of the basket at 90° to the wall

i. *BS 7671:2018 (IET Wiring Regulations Eighteenth Edition), which was published in January 2018 and comes into effect on 1 January 2019, will include a requirement that wiring systems all locations. The requirement is included in a new regulation (Regulation 521.10.202), which is reproduced below.*

521.10.202 Wiring systems shall be supported such that they will not be liable to premature collapse in the event of a fire.

NOTE 1: Wiring systems hanging across access or egress routes may hinder evacuation and firefighting activities.

NOTE 2: Cables installed in or on steel cable containment systems are deemed to meet the requirements of this regulation.

NOTE 3: This regulation precludes, for example, the use of non-metallic cable clips or cable ties as the sole means of support where cables are clipped direct to exposed surfaces or suspended under cable tray, and the use of non-metallic cable trunking as the sole means of support of the cables therein.

NOTE 4: Suitably spaced steel or copper clips, saddles or ties are examples that will meet the requirements of this regulation.

- Plastic trunking shall not be mounted on walls or ceilings within escape routes.

i. *BS 7671:2018 (IET Wiring Regulations Eighteenth Edition), which was published in January 2018 and comes into effect on 1 January 2019, will include a requirement that wiring systems all locations. The requirement is included in a new regulation (Regulation 521.10.202), which is reproduced below.*

521.10.202 Wiring systems shall be supported such that they will not be liable to premature collapse in the event of a fire.

***NOTE 1:** Wiring systems hanging across access or egress routes may hinder evacuation and firefighting activities.*

***NOTE 2:** Cables installed in or on steel cable containment systems are deemed to meet the requirements of this regulation.*

***NOTE 3:** This regulation precludes, for example, the use of non-metallic cable clips or cable ties as the sole means of support where cables are clipped direct to exposed surfaces or suspended under cable tray, and the use of non-metallic cable trunking as the sole means of support of the cables therein.*

***NOTE 4:** Suitably spaced steel or copper clips, saddles or ties are examples that will meet the requirements of this regulation.*

5.11.2 Suspended Floor Containment

All cables within suspended flooring shall:

- All raised flooring shall have a minimum height of 200mm
 - *EN 50174-2 – Requirements – Section 4.5.3.1 – ‘Minimum height between floor tile and underside of access floor tile shall be a minimum of 50mm clearance’*
- The minimum height from the top of a cable bundle to the underside of the false floor shall not be less than 50mm.
 - *EN 50174-2 – Requirements – Section 4.5.3.1 – ‘Minimum height between floor tile and underside of access floor tile shall be a minimum of 50mm clearance’*
- Cable basket supported by 41mm Unistrut bars
 - *EN 50174-1 – Requirements – Section 4.3.1.1 – Pathways constructed using tray-work shall be located to:*
 - *provide a minimum clearance of 25 mm from the fixing surface;*
 - *provide the greatest working space possible subject to a minimum of 150 mm above the tray to enable access during installation;*
 - *meet the applicable cable minimum bend radius requirement;*
 - *prevent damage to the installed cabling.*
- Where cables are installed within suspended floors the containment shall be accessible along the entirety of its length

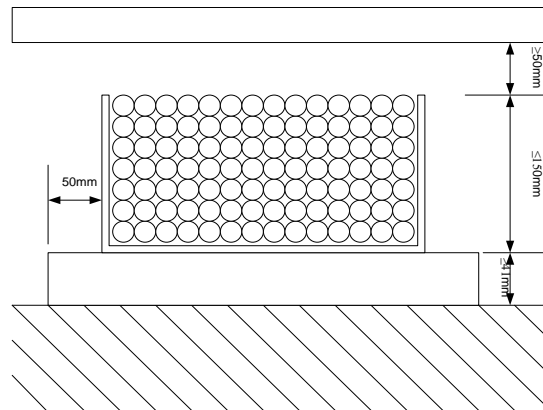
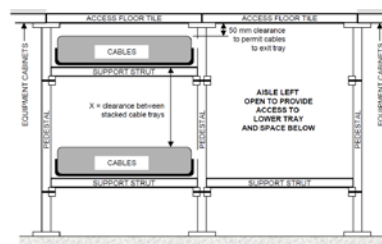
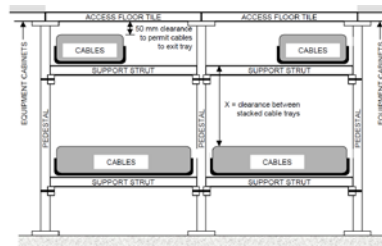

Figure 60 Suspended floor cable basket

- The containment run shall be in excess of 300mm from other containment and services on at least one side
 - i. Where cable management systems are vertically stacked and run in parallel to provide additional capacity:*
 - a) access to lower layers shall be provided by either using narrower cable management systems for upper layers (as shown in figure below) or by providing an accessible row of adjacent tiles (as shown in figure below);*



5.11.3 Suspended Ceiling Containment

All cables within suspended ceiling shall:

- All cables to be installed at high level on suspended cable basket – cable tray is not acceptable
 - i. Cable tray cannot accommodate high depths of cable stacking*

- High level cable basket to be suspended at a height of ≥ 200 mm below all points of the ceiling slab where reasonably practical
 - i. *EN 50174-1 – Requirements – Section 4.3.1.1 – Pathways constructed using tray-work shall be located to:*
 - provide a minimum clearance of 25 mm from the fixing surface;
 - provide the greatest working space possible subject to a minimum of 150 mm above the tray to enable access during installation;
 - meet the applicable cable minimum bend radius requirement;
 - prevent damage to the installed cabling.
- High level cable basket to be suspended at a height of ≥ 75 mm above all points of the suspended ceiling
 - i. *A requirement of TIA 569*
- Basket to be supported by trapezes. It is important to note that once the cable basket enters a telecom room the threaded rods shall be A2 stainless steel
- Threaded rods to be secured to the ceiling slab and shall be capable of holding the maximum number of cables plus a safety margin of 100%
- Lighting and sprinkler systems shall not be impeded by basket work
 - i. *EN 50174-2 – Requirements – Section 4.3.2.1 – ‘The location of aisles separating rows of cabinets, frames or racks should be co-ordinated with lighting and fire protection plans:*
 - c) *lighting should be placed above aisles and not above cabinets, frames, racks and overhead pathways;*
 - d) *pathways should not be located where they interfere with the intended operation of fire suppression systems such as water distribution from sprinkler heads.*

Pathways should not restrict access to other building infrastructures that require periodic maintenance e.g. valves, electrical receptacles and smoke detectors. Under-floor pathways should not be located above such equipment unless there is an accessible row of tiles adjacent to these pathways.
- Cable basket shall be installed such that cables can be placed into the basket, not clipped to the underside.
 - i. *BS 7671:2018 (IET Wiring Regulations Eighteenth Edition), which was published in January 2018 and comes into effect on 1 January 2019, will include a requirement that wiring systems all locations. The requirement is included in a new regulation (Regulation 521.10.202), which is reproduced below.*

521.10.202 *Wiring systems shall be supported such that they will not be liable to premature collapse in the event of a fire.*

NOTE 1: *Wiring systems hanging across access or egress routes may hinder evacuation and firefighting activities.*

NOTE 2: *Cables installed in or on steel cable containment systems are deemed to meet the requirements of this regulation.*

NOTE 3: *This regulation precludes, for example, the use of non-metallic cable clips or cable ties as the sole means of support where cables are clipped direct to exposed surfaces or suspended under cable tray, and the*

use of non-metallic cable trunking as the sole means of support of the cables therein.

NOTE 4: *Suitably spaced steel or copper clips, saddles or ties are examples that will meet the requirements of this regulation.*

- At a minimum of every 6000mm along the length of the containment run a person shall be able to gain access to the containment
 - At every change in direction of the containment run a person shall be able to gain access to the containment
 - At every change in height of the containment run a person shall be able to gain access to the containment
 - Cable basket access hatches shall have a square aperture of 550 x 550mm.
 - Cable basket shall be used along its entirety for bundle sizes of 5 or more cables. Where the cable basket meets trunking or copex vertical drops they shall be within 200mm of each other
 - Cable bundles of 4 or less cables should be installed in cable basket but may be installed in rigid or flexible copex. If copex is used, it shall be:
 - 32mm in diameter
 - Finish within 150mm on the trunking/copex vertical drop
 - Be glanded to the cable basket at the exit point
 - Be glanded to the outlet with proprietary mini trunking clip or copex gland
 - Total copex run shall be ≤ 4000 mm
 - There shall be a ceiling fixing within 150mm either side of a change in direction
 - All ceiling fixing SHALL be metallic and shall be at ≤ 1500 mm centres. This includes the copex saddle and the screws/bolts/pins
- i. EN 50174-2 – Requirements – Section 4.4.1.3. – ‘for pathway systems that provide non-continuous support (e.g. basket, ladder or hooks):
– the maximum distance allowed between supporting elements of the pathway system is 1500 mm;*

- ii. BS 7671:2018 (IET Wiring Regulations Eighteenth Edition), which was published in January 2018 and comes into effect on 1 January 2019, will include a requirement that wiring systems all locations. The requirement is included in a new regulation (Regulation 521.10.202), which is reproduced below.*

521.10.202 *Wiring systems shall be supported such that they will not be liable to premature collapse in the event of a fire.*

NOTE 1: *Wiring systems hanging across access or egress routes may hinder evacuation and firefighting activities.*

NOTE 2: *Cables installed in or on steel cable containment systems are deemed to meet the requirements of this regulation.*

NOTE 3: *This regulation precludes, for example, the use of non-metallic cable clips or cable ties as the sole means of support where cables are*

clipped direct to exposed surfaces or suspended under cable tray, and the use of non-metallic cable trunking as the sole means of support of the cables therein.

NOTE 4: *Suitably spaced steel or copper clips, saddles or ties are examples that will meet the requirements of this regulation.*

○

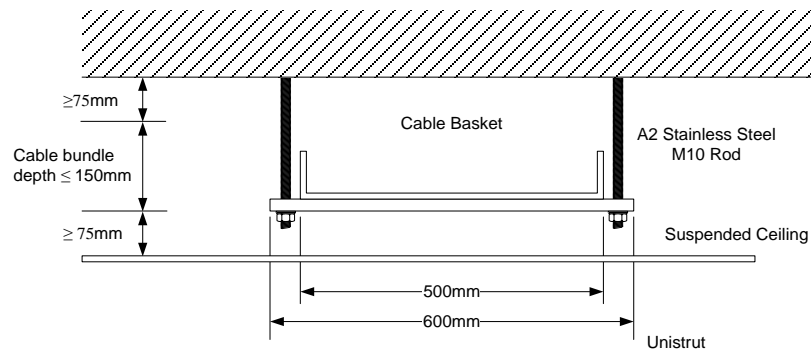

Figure 61 Suspended ceiling cable basket

The Unistrut trapeze must be spaced at a maximum of 1.5m centres.

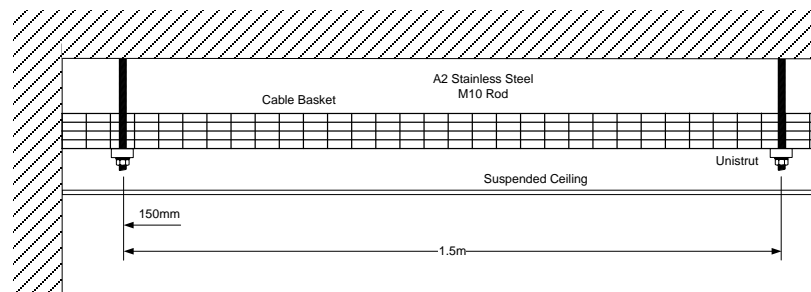

Figure 62 Suspended ceiling cable basket side elevation

5.12 Trunking

A system of perimeter dado trunking, to be installed by the electrical installer, will be used to distribute cabling to service positions. This trunking system to be specifically **MK Prestige 2COM**.

Dado trunking shall:

- Dado level trunking system linking to the horizontal basket distribution shall only be accomplished by a vertical section of trunking from the dado section to the suspended ceiling/floor void
- Each room shall have its own vertical section of trunking
- Not be fed by conduit drops

- Not be fed through the walls from adjoining rooms
- Not be used in ceiling voids
- Not be screwed to ceiling slab
- Not be used in escape routes

5.13 Screed Trunking

Screed trunking shall:

- Be the same width as the floor box
- **Separate compartment dedicated to data cables only**
- Where connected to vertical risers the manufactures vertical bend shall be used
- Accessible junction box shall be used at all changes in direction
- Shall be constructed from a minimum of 18swg galvanised steel
- Shall be bonded to earth in accordance with BS 7671
- **Floor boxes shall not take up any of the trunking capacity i.e. it shall sit on top of the trunking**
- Finished screed surface shall be ≥ 25 mm above the top of the trunking

5.14 Resilience

When designing the floor areas, it is important to consider the resilience to the outlets. To keep the concept of resilience simple there shall be two levels. Level 1 shall be lowest level and level 2 the highest. Level 1 is reserved for a 336-channel design and level 2 for a 672-channel design.

5.14.1 336 Channels – Level 1

Each switch shall be powered from a different PDU within the back of the cabinet to provide further resilience.

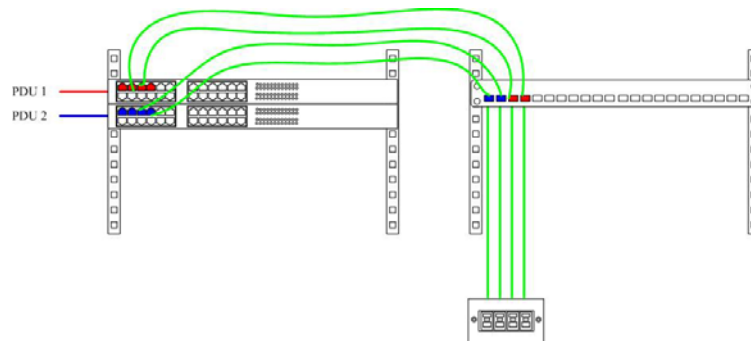

Figure 63 Level 1 resilience

Worst-case outage from power failure on any one spur is 50%. Catastrophic power failure to the telecoms room means a 100% outage or at best will be limited to the UPS(s) power rating(s).

5.14.2 672 Channels - Level 2

There are two active cabinets and two structured cabling cabinets. Each active cabinet may only be patched into its adjacent structured cabling cabinet. This effectively splits the row of 4 cabinets into 2, namely an A route and a B route.

The A route patching field shall be fed from two separate PDUs and the B route patching field from a further two separate PDUs.

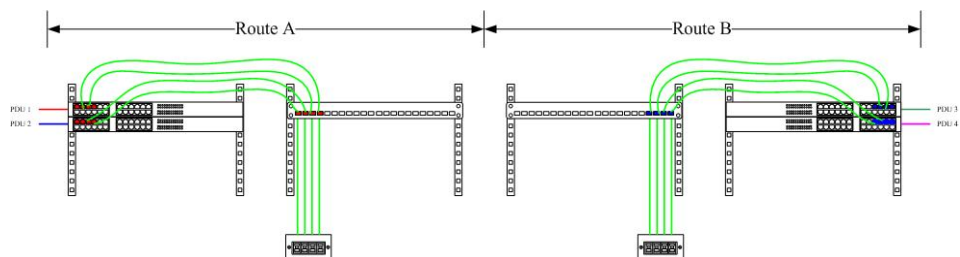

Figure 64 Level 2 resilience

Worst-case outage from power failure on any one spur is 25%.

Catastrophic power failure to the telecoms room means a 100% outage or at best will be limited to the UPS(s) power rating(s).

5.15 Copper Testing

All horizontal permanent copper links shall be tested prior to patching of network switches.

Copper test results are presented before go live and after telecom room sign off/handover to allow go live to take place with a go live change.

For each test, a testing unit shall be used to produce a measured result and determine whether the result is within the specified limits of EN 50173. The unit shall be configured to store enhanced plot data within the overall test record.

An overall PASS / FAIL shall be provided for each test, and a measured result for all the pairs shall be provided. For each test, the worst-case value or margin to a limit and the frequency shall be reported.

The method of test equipment utilisation shall be strictly in accordance with CommScope's testing instructions. The latest instructions shall be sought from CommScope before testing commences.

Test results shall be issued to iSolutions as part of the sign off process for hub rooms, along with as fitted drawings indicating data outlet positions and outlet numbering.

6 Backbone Distribution

6.1 Overview

The backbone distribution is split into two areas, namely the Campus Distribution (CD) backbone and the Building Distribution (BD) backbone. The CD backbone links buildings together whilst the BD backbone links telecom rooms within buildings.

The Campus Backbone distribution extends from the CDs to any subsequent CDs in other buildings on the same campus; and from the CDs to the BDs within all remaining buildings on that same campus. The CDs are typically located in DERs, and the BD' in MERs.

The Building Backbone distribution extends from and between the BDs in each building to the FD(s) in the same building. The BDs are typically located in MERs, and the FD's in SERs.

It is critical that the backbone distribution is designed correctly and consideration given to:

- Data communications media choice
- Layouts
- Routing
- False floor
- Ceiling void
- Cable management

6.2 Media Choice

6.2.1 OS2 / Blown Fibre

All new Campus Backbone fibre links shall be blown fibre OS2, regardless of whether the building has traditional fibre that is not being refreshed.

For new buildings or buildings that will be refurbished/refreshed, then the Building Backbone fibre cable shall be blown fibre OS2.

For existing buildings that have traditional fibre already installed and where there is an additional requirement for new Building Backbone links, then the fibre cable shall be blown fibre OS2.

All fibre cores shall be terminated on LC duplex pigtails by fusion splicing. It is not acceptable to use mechanical splicing techniques.

6.3 MER and Building Incoming Fibre Design

Dual entrance fibre designs shall be achieved for all new buildings and any refurbishments of existing buildings.

Each MER shall have:

- A blown fibre ring to feed the building. The size and number of tube and tube units to be specified by iSolutions
- A minimum of one 12 core OS2 fibre DER trunk - to each MER
- A 4 way external blown fibre tube unit from the main blown fibre ducting to the building entry gas seal unit – to each MER
- A gas seal unit at the building entry – to each MER
- A 4 way LSOH blown fibre tube unit from the gas seal unit to each MER.
- Each DER trunk shall not share the same building entry
- Each DER trunk shall not share the same external ducting route
- Each DER trunk shall not share the same internal containment route
- Each DER trunk shall feed a different MER
- A plastic fibre patch panel with 12 off LC connectors. One to be fitted at each end of each DER trunk
- The MERs shall be meshed together with 2 off 4 way LSOH blown fibre tube units. The tube units shall be diverse routed
- The MERs shall be meshed with 2 off 12 core OS2 blown fibre cables – one in each of the 4 way blown fibre tube units
- A split fibre patch panel with 16 off LC connectors One to be fitted at each end of the MER meshed fibre backbone. The patch panels shall share the A and B leg

The SER shall have:

- A minimum of two 8 core OS2 fibre MER trunks – one from each MER
- A minimum of two off 4 way blown fibre tubes – one from each MER
- Each SER trunk shall not share the same route
- Each SER trunk shall come from a different MER
- A plastic fibre patch panel with 8 off LC connectors. One to be fitted at each end of each MER trunk.
- A split fibre patch panel with 16 off LC connectors A leg to be terminated into the top drawer and the B leg into the bottom. One to be fitted at the SER.

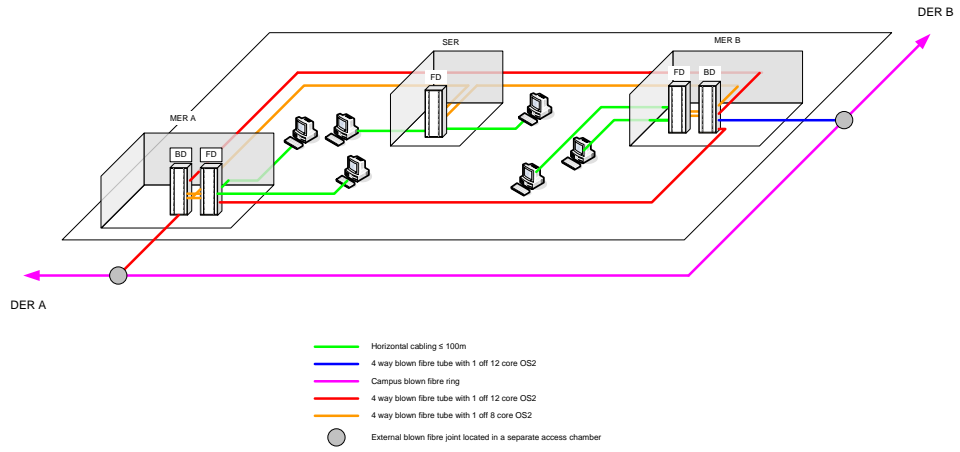

Figure 65 Double MER blown fibre

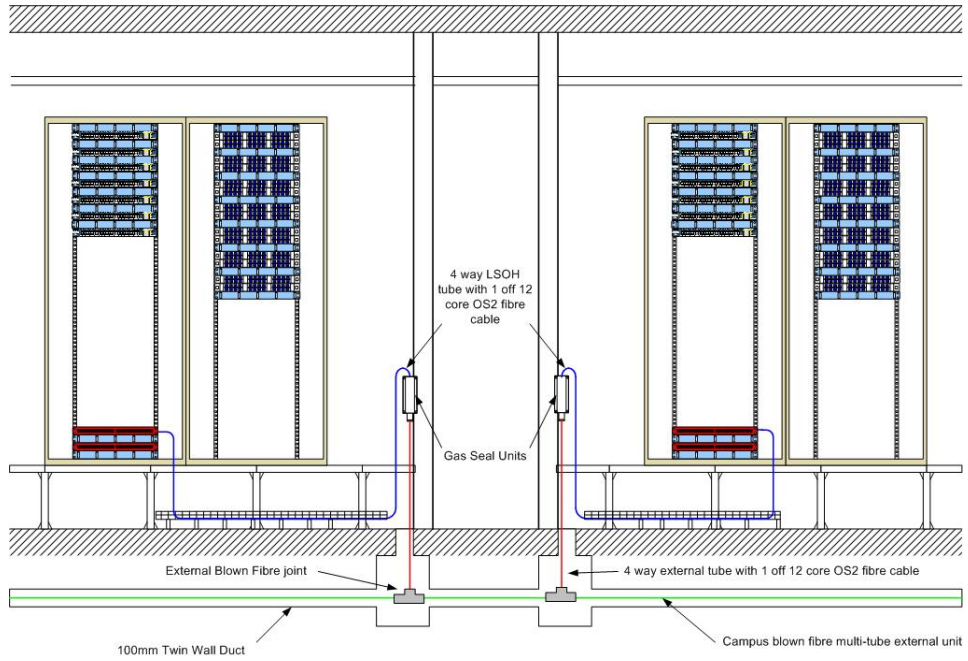

Figure 66 Campus distribution for a double MER

6.4 Fibre Polarity

All installed fibre cables, installed between two patch panels, shall have each pair flipped. All fibre patch cords shall be flipped.

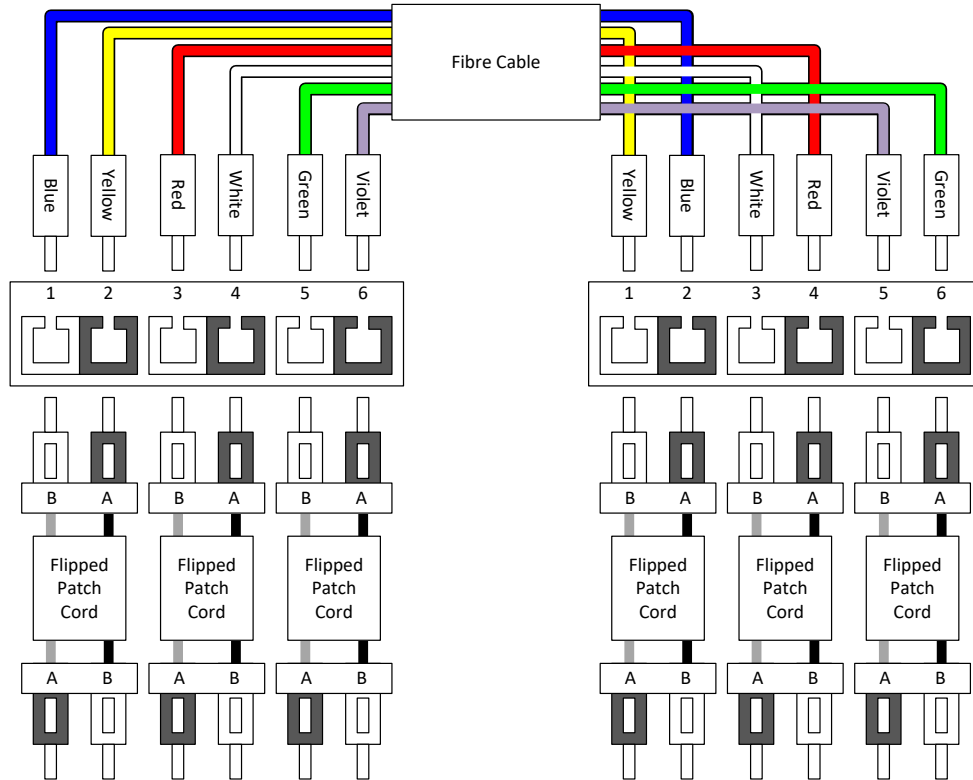

Figure 67 Fibre polarity

6.5 Fibre Joint Arrangements

The two options for the fibre joint arrangements are dual and single. The rules for dual and single are detailed in the previous section.

6.5.1 Dual Joint Arrangement

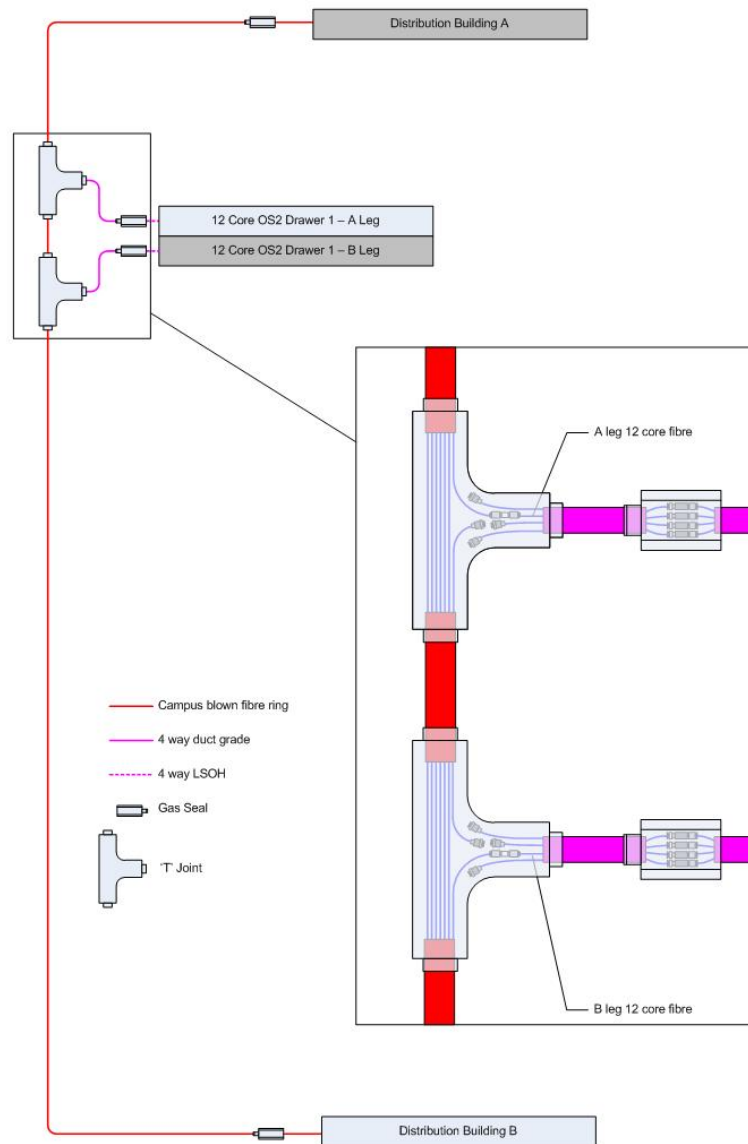

Figure 68 Dual blown fibre joint arrangement

Where a building needs a feed from the blown fibre campus ring the ring shall be broken into at the two diverse access chambers. The same tube shall be cut in both the chambers i.e. if tube 2 is cut in the chamber that will provide the A leg then tube 2 shall also be cut in the chamber that feeds the B leg.

The cut tube that now links chamber A and B shall be capped off with an external end blocking cap. The A leg tube shall be jointed onto the first 4 way blown fibre building feed and the B leg feed must be jointed onto the second 4 way blown fibre building feed. All tubes that are not to be used in the two off 4 way building feeds shall be capped off with external end blocking caps.

6.5.2 Single Joint Arrangement

Where a building needs a feed from the blown fibre campus ring the ring shall be broken into at the single access chamber. The required tube shall be cut. The A and B leg tube shall be jointed onto the 4 way blown fibre building feed. All tubes that are not to be used in the 4 way building feed shall be capped off with external end blocking caps.

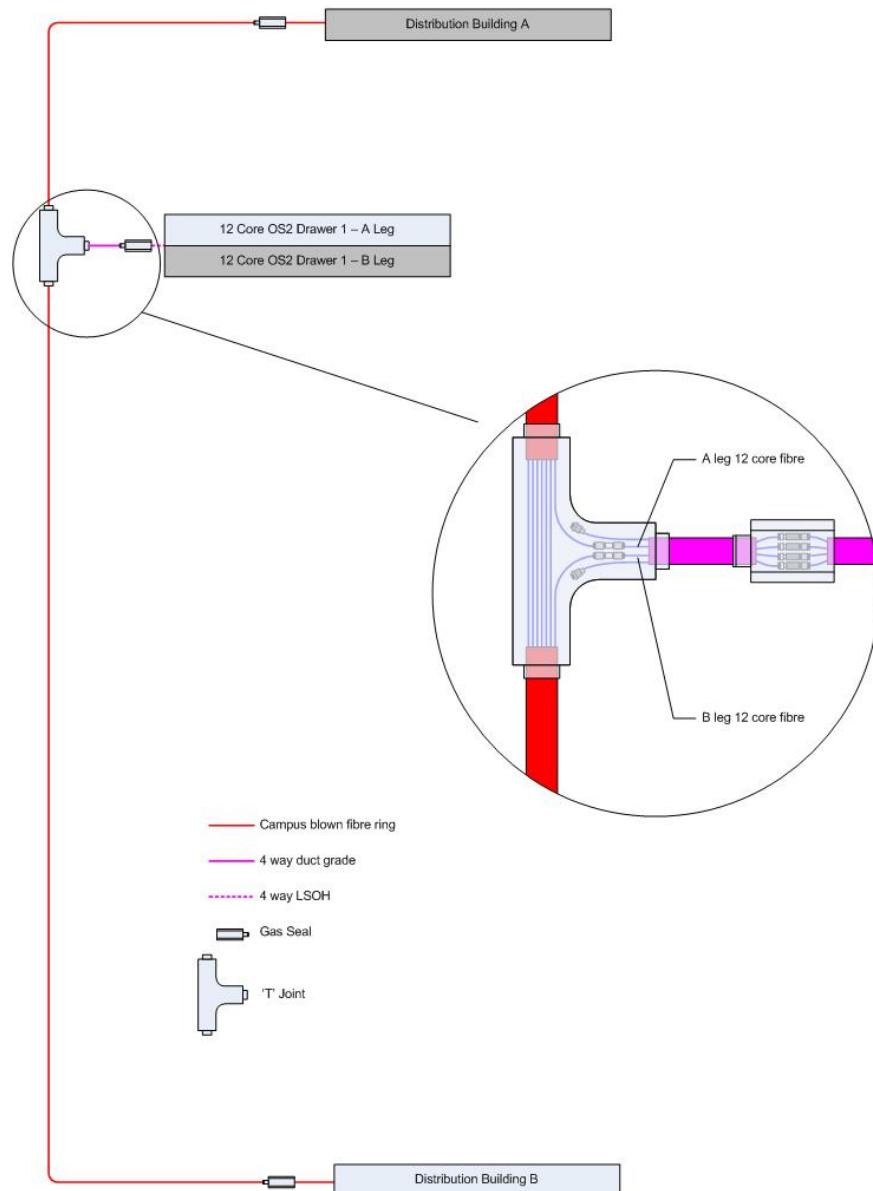

Figure 69 Single blown fibre joint arrangement

6.6 Fibre Backbone Testing

The following requirements shall be met when performing testing and commissioning on backbone fibre cabling systems.

Fibre test results are presented before go live and after telecom room sign off/handover to allow go live to take place with a go live change.

All backbone fibre cabling systems shall be tested against the requirements of Appendix H. The Contractor shall seek at time of installation guidance from TE on the most up to date and appropriate testing documentation.

Each fibre optic core shall be tested to confirm that it meets the insertion loss requirements, as detailed in EN 50173-1. Multimode fibre shall be tested at 850nm and 1300nm wavelengths. Singlemode fibre shall be tested at 1310nm and 1550nm wavelength. Tests shall be made in both directions of each core of the installed cable. For each optical fibre channel the following test results shall be recorded:

- Power meter measurements to verify:
 - Overall attenuation to the nearest 0.1dB in both directions
 - Confirmation of polarity and mapping of fibre cores onto patch panel terminations
- Fluke Fibre Optic Cable Tester to verify:
 - Cable PASS or FAIL
 - Any basic information on the state of the link measured by the selected Fluke tool.
- OTDR Measurements to:
 - Characterise the fibre link and its events with a recorded trace record
 - Identify stressed fibre and severe bends
 - Detect bad connections, terminations and splices
 - Measure fibre length

Failures detected during testing shall be duly noted. All faults shall be rectified by The Contractor and any damaged cables shall be replaced with new cables in complete runs. Cable joining or running of part segments shall not be accepted; all equipment presenting failures shall be replaced by new equipment.

Test results where the result is closer to the limit than the tolerance of the test equipment may be noted as 'PASS*'. A 'PASS*' test result shall have terminations remade and retested. In the event the result remains a 'PASS*' it shall be treated as a pass.

6.6.1 Witness Tests

iSolutions, or a University Representative, reserves the right to attend site to witness cable tests and complete random sample testing upon completion of tests. Witness testing and random sample testing shall be agreed with The Contractor prior to commencement.

6.6.2 Test Records

Testing records shall be documented electronically in their original format and written to a CD-ROM where upon completion of testing they shall be reviewed by The Client. The Contractor shall free issue any software required to read the test results.

6.6.3 Test Equipment

The model and serial number of any test equipment used shall be recorded for each relevant test.

7 Emergency Voice Communication (EVC)

7.1 Overview

All general telephones shall be VoIP based and as such do not form part of this section. The only traditionally based voice switch telephones shall be public emergency phones, equalities act, refuge call points, critical alarms and lift phones.

The voice distribution covers campus and building distribution for BT and the University of Southampton voice cabling. The BT cabling solution is to be specified and provided by BT and as such does not come under the specification of this document. This specification covers the University of Southampton voice cabling and from the demarcation of BT to the equipment.

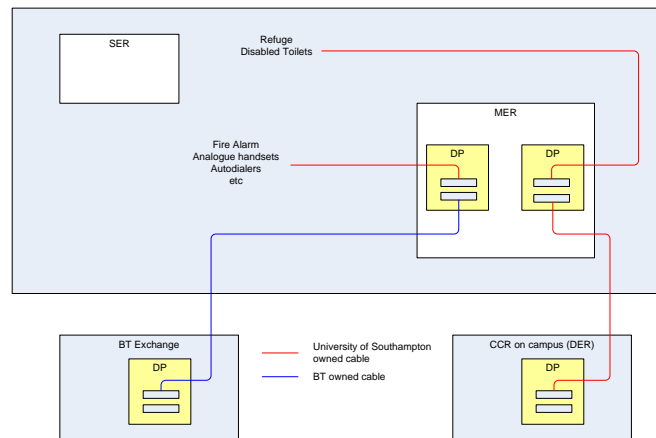

Figure 70 University and BT demarcation for voice cabling

The campus voice distribution for a new build extends from the main telecommunications room to the nearest campus exchange.

The EVC copper trunk supply cable shall be terminated in a DP within the MER.

7.2 External/Internal Trunk Cable Media Selection

Cable types, pair count and where they are used are normally:

- Internal/external – 50 pair CW1308FLH (LSOH version of CW1308)

Clarification must be sought from iSolutions on the final number of pairs to be installed

7.3 Internal Horizontal Cable Media Selection

Cable types, pair count and where they are used are normally:

- Internal Horizontal – FireTuf[®] grade cables capable of fire resistant to BS5839 26.2E > 2hrs @ 950°C, BS6387 > 3hrs @ 950°C and BS EN 50200 > 3hrs @ 950°C

7.4 Use Case Outlet Quantities

Each use case type will demand different requirements from a voice block wiring infrastructure. The main use case and associated technologies have been defined below as the minimum requirements for outlet concentrations.

Use Case	LJU Outlets	Direct Terminated
Disabled Toilet	1 per room (4 pairs)	1 per room (1 pair)
Public Emergency/DDA Phone	1 per position (4 pairs)	
Lift Telephony	1 per lift (4 pairs)	
Fire Alarm		1 per position (4 pairs)
Autodialers		1 per position (4 pairs)
EVC call point as a result of risk assessment for hazardous area of activity		1 per position (4 pairs)

7.5 Emergency Voice Design

The voice design is split into two links, the campus distribution and the building distribution.

The internal/external voice cable may be installed on existing cable basket that is dedicated to structured cabling. Where there is no suitable existing containment then new cable basket shall be fitted. The basket shall be 50mm in width.

The Contractor shall be responsible for procuring, installing, testing and commissioning of the building EVC components in conjunction with the University of Southampton. iSolutions will be responsible in connecting and activating the building EVC solution on to the core critical network.

The main contractor will be responsible for procurement and installation of:

- Call points
- Building wiring
- DP in MER
- Copper trunk cable install back to B85
- Connection at B85
- Cost of a new line card for the EVC exchange
- For sites over 7Km where fibre is installed each site core shall be fitted with a UPS at both ends
- Testing and commissioning
- The University will be responsible for commissioning of new building on to the EVC exchange

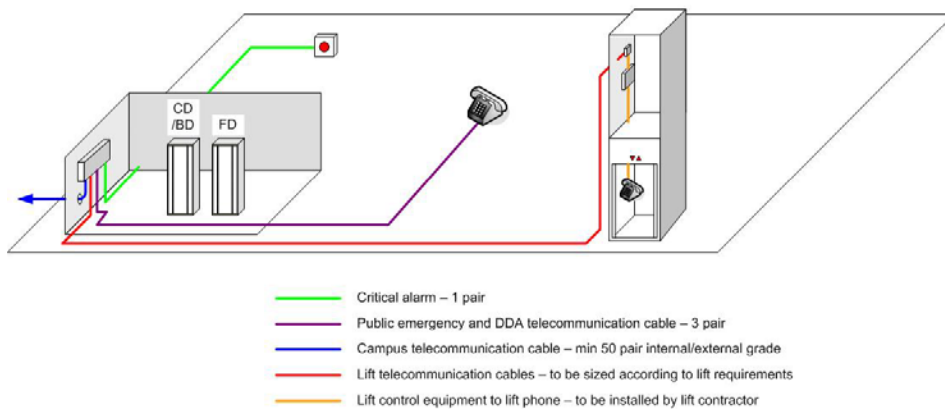

Figure 71 Voice block wiring design

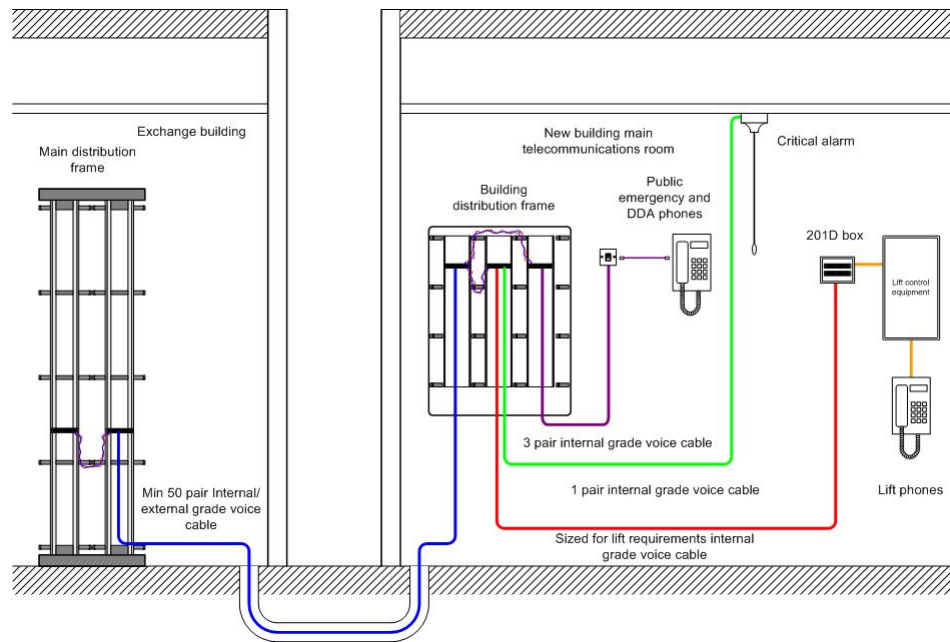

Figure 72 Building distribution backbone

7.5.1 University of Southampton Campus Emergency Voice Trunk

The campus emergency voice distribution for a new build extends from building 85 voice distribution frame/box to the emergency voice distribution frame/box within the allocated MER.

Where a direct point to point copper link cannot be installed, a highly available alternative connection shall be provided – for example a PSTN trunk.

The voice distribution frame/box shall act as a jumpered cross connect.

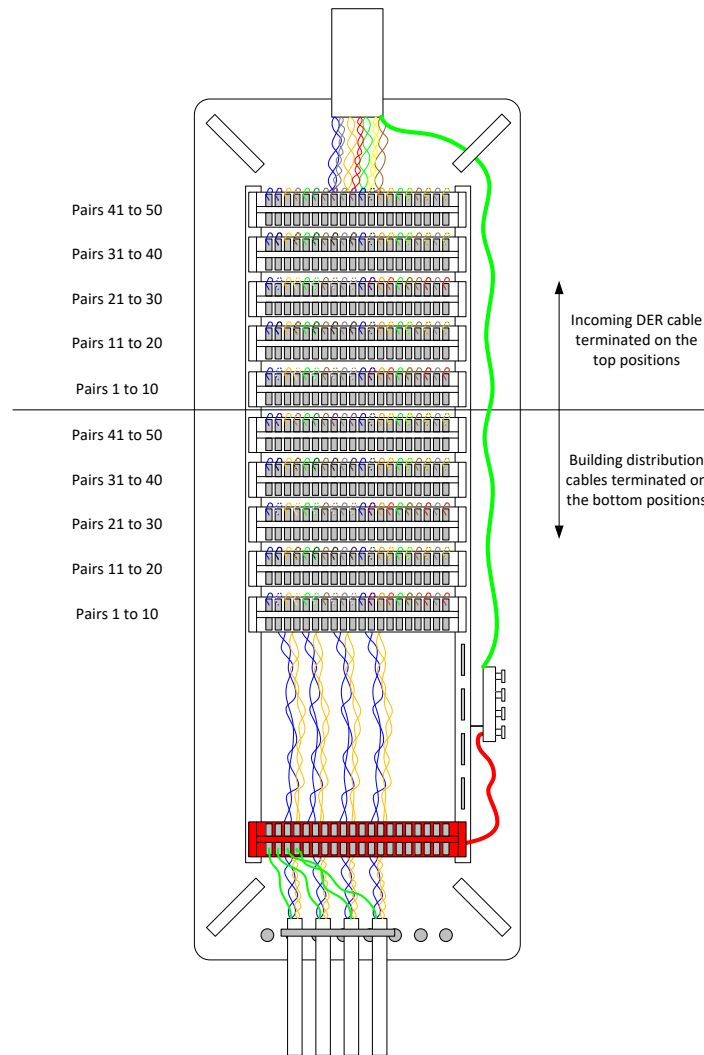

Figure 73 Telco DP box showing jumpered cross connect

Each trunk link shall consist of:

- 1 qty suitably sized CommScope KRONE 237 voice frame, cabinet or wall box in the MER (sized to accommodate the 50 pair cable or to be specified by iSolutions and a further 50 pairs for distribution and a single voice earth module)
- 1 qty printed label – frame, cabinet or wall box
- 1 qty internal/external 50 pair voice cable (or to be specified by iSolutions) – length to be determined by Contractor
- 10 qty 237A 10 pair disconnect module (this number may change depending on the cable size)
- 10 qty 51A hinged label holder (this number may change depending on the cable size)
- 10 qty printed label – 51A label holder (this number may change depending on the cable size)
- 1 qty red 10 pair earth module
- 1 qty green earth sleeve for each EVC cable
- Velcro type ties – suitable quantity for installation (every 300mm within the communications room and every 600mm outside of the communications room. Additional Velcro type ties shall be used as necessary)

- XX qty cable label for each 50 pair cable run – approved type of cable label at each end of the cable run, each manhole, building entry, riser floor and ceiling access points

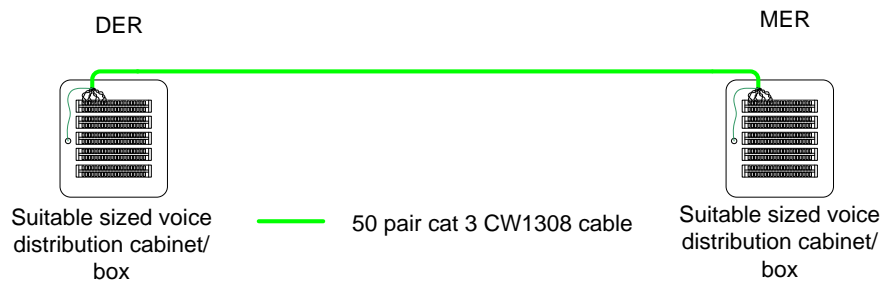

Figure 74 Campus voice link design

7.5.2 Refuge and Disabled Toilets – From the University of Southampton DP

The building emergency voice distribution extends from the voice distribution frame or wall box within the MER/SER to the terminal equipment or TO i.e. fire alarm, refuge point etc.

Each link shall consist of:

Each phone distribution extends from the voice patch panel within the MER/SER to the TO.

Each link shall consist of:

- 1 qty 237A 10 pair disconnect module mounted in the MER frame, cabinet or wall box
- 1 qty 51A hinged label holder
- 1 qty printed label – 51A label holder
- 1 qty LJU
- 1 qty single or double gang back box
- 1 qty outlet label
- 1 qty gland for outlet
- 1 qty 4 pair cat 5e SF/UTP FireTuf[®] cable – length to be determined by Contractor
- 1 qty green earth sleeve for each FireTuF cable
- Velcro type ties – suitable quantity for installation (every 300mm within the communications room and every 600mm outside of the communications room. Additional Velcro type ties shall be used as necessary)
- 2 qty cable label for each FireTuf[®] cable run – approved type of cable label at the DP and TO.

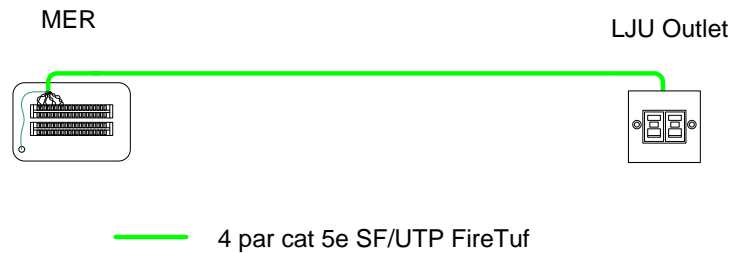

Figure 75 Refuge and disabled toilets telephony

7.5.3 Fire Alarm, Critical Alarm, Refuge Call Point, Autodialers etc – From the BT demarcation point

The building emergency voice distribution extends from the voice distribution frame or wall box within the MER/SER to the terminal equipment or TO i.e. fire alarm, refuge point etc.

The refuge call point product specification is presented in Appendix F.

Each link shall consist of:

- 1 qty 237A 10 pair disconnect module mounted in the MER frame, cabinet or wall box
- 1 qty 51A hinged label holder
- 1 qty printed label – 51A label holder
- 1 qty LJU
- 1 qty single or double gang back box
- 1 qty outlet label
- 1 qty gland for outlet
- 1 qty 4 pair cat 5e SF/UTP FireTuf[®] cable – length to be determined by Contractor
- 1 qty green earth sleeve for each FireTuf cable
- Velcro type ties – suitable quantity for installation (every 300mm within the communications room and every 600mm outside of the communications room. Additional Velcro type ties shall be used as necessary)
- 2 qty cable label for each FireTuf[®] cable run – approved type of cable label at the DP and TO.

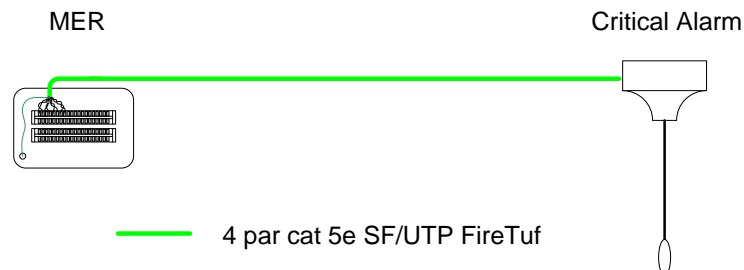

Figure 76 Fire alarm, critical alarm, autodialers etc.

7.5.4 Lift Telephony – From The University of Southampton DP

All lift telephony on new building projects shall be provided by the EVC system. Where no EVC is provided an auto-dialler shall be installed.

- 1 qty suitably sized CommScope KRONE 237 wall box located in the lift plant room
- 1 qty printed label –wall box
- XX qty 237A 10 pair disconnect module at each end (4 pairs for each lift telephone)
- XX qty 51A hinged label holder at each end (4 pairs for each lift telephone)
- XX qty printed label – 51A label holder at each end (4 pairs for each lift telephone)
- XX qty 4 pair cat 5e SF/UTP FireTuf[®] cable – length to be determined by Contractor (4 pairs for each lift telephone)
- Velcro type ties – suitable quantity for installation (every 300mm within the communications room and every 600mm outside of the communications room. Additional Velcro type ties shall be used as necessary)
- 2 qty cable label for each FireTuf[®] cable run – approved type of cable label at the patch panel and TO.

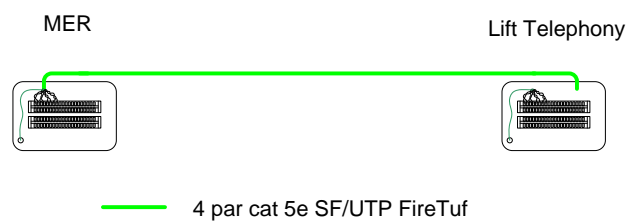

Figure 77 Lift telephony

8 Auditing

8.1 CommScope Audit

iSolutions reserves the right to request an audit from a CommScope representative on the structured cabling element of the project. The CommScope representative shall be given access to all areas where structured cabling products have been installed or are to be installed.

The installer shall provide, at the request of the CommScope representative, sufficient resources to assist in the removal of ceiling tiles, access equipment for high level access, lifting floor tiles, lifting man hole covers etc.

Any areas of concern that may impact on the warranty, at the time of inspection or during the 25 year warranty period, shall be resolved at the cost of the installer. Any areas of concern that do not impact the warranty, now or during the 25 year warranty period, but are deemed to not fulfil the requirements of this specification or industry good practices, shall be resolved at the cost of the installer.

8.2 iSolutions Audit

iSolutions reserves the right to audit all elements of the project as defined by this specification and industry best practices. The iSolutions representative shall be given access to all areas.

The installer shall provide, at the request of the iSolutions representative, sufficient resources to assist in the removal of ceiling tiles, access equipment for high level access, lifting floor tiles, lifting man hole covers etc.

Any areas of concern that conflict or fail to comply with this specification shall be resolved at the cost of the main contractor.

8.3 iAuditor

iSolutions have standardised on iAuditor together with templates provided by Ethicus Consultancy Ltd. The installer shall engage with Ethicus Consultancy on a project by project basis and build into their costs a project-based fee to cover access of the templates to iSolutions requirements. This cost shall be included the integrators bid to the main contractor and highlighted as 'iAuditor templates construction'.

Engagement and access to iAuditor is mandatory for all projects requiring copper and fibre work packages for the university and will be measured against current UOS specification version in force at the time.

A template shall be made available to the IT Integrator and this template shall be used as a pre-commissioning tool for all work indicated within the iAuditor template. It is not acceptable for the IT Integrator to not complete the template together with photographic evidence where requested. The IT Integrator shall build into their costs a license from iAuditor.

The contact details for Ethicus Consultancy Ltd are:

- Karl Tryner
- Email: karl.tryner@gmail.com
- Tel: 01242 620906
- Mob: 07768 325759

9 Roles and Responsibilities

9.1 General

The design of the cabling system will include input from the Building Designer, Main Building Contractor, Electrical Contractor, Specialist Data Contractor, Estates and Facilities Project Leader and iSolutions. Close liaison between all parties is required to deliver building design and services suitable for installation of structured cabling to EN 50173 & EN 50174.

It is anticipated that the Main Contractor shall appoint a competent Data Contractor. Corporate membership by the Data Contractor of BICSI and individual qualification to BICSI RCDD standard should be considered favourably alongside other accreditations the Main Contractor may require.

Key points to take into account during the design phase include

- Number of points required
- Cable pathways
- Building and Floor distributors (hub rooms) specification
- Power and cooling
- Component choice
- Installation scheduling
- Quality control

9.2 Responsibilities

The responsibilities for the installation of the cabling system, supply and installation of the data network components to a commissioned solution in compliance with all university specifications are as follows:

9.2.1 Building Designer

- Provide Building Distributors and Floor Distributors (hub rooms) to the specification provided by iSolutions (below).
- Provide details of locations and quantities of hub rooms and data outlets along with detailed drawing to iSolutions. Accurate drawings are to be issued prior to start of cabling system installation showing individual outlet positions with single/double/quad outlets being clearly marked. As a guide, in single occupancy offices there should be a minimum of three data points installed within 1.5m of the anticipated primary desk location.
- Building/floor distributors (hub rooms)
Ensure that there are adequate hub rooms to service the building and that no office outlet is more than 90 metres cable distance from a hub room.
Design each hub room to accept at least one 800mm x 800mm equipment racks.
The space required for a room containing two racks is approx. 2800mm x 2000mm to allow an engineer to gain safe access to the front, rear and side of rack, and the doors to open fully.
As an estimate, the amount of space required within a rack for active equipment shall be equal to the amount of space taken by passive components.

9.2.2 Main Contractor

- Provide services to support equipment racks in each hub room. To include power, cooling (air conditioning), lighting, fire detection and containment for cabling.

- Provide cable pathways sufficient to accommodate structured cabling system (including allowance for any future expansion).
- Ensure earthing and bonding compliance to BS EN 50310.
- Provide two diverse duct routes into the building, linking into the existing University duct system so as to provide diverse routing of cables to the Data Network core.
- Provide all MAC address information for all installed network-enabled equipment. This shall be communicated by populating the table in Appendix G.
- Design cabling system.
- Supply and install equipment racks.
- Install and test of cabling system.
- Install and test of fibre optic links between hub rooms.
- Supply and installation of all sundry rack accessories stated elsewhere in this document, including cable management arms.
- No IP addresses shall be allocated until this information has been provided to the University of Southampton.
- Design of data network at a physical and logical level in compliance with issued UOS specifications, approval required by iSolutions
- Supply of all data networking hardware
- Supply and patch all copper circuits to active data network switches
- Supply and clean fibre patch leads prior to installation
- Design of the wireless data service in compliance with UOS issued wireless specifications seeking approval from iSolutions.
- Supply of all wireless access points
- Patch all mains cords of network hardware
- Installation of all data networking switches
- Pre stage for configuration all data network hardware and wireless access points
- Supply and patch of all fibre patch cords
- Supply and install all cat 6a 0.5m patch cords for APs
- Completion of all fibre patching and labelling
- Completion of all copper patching and labelling
- Install and test fibre optic links to the University's data network (external to the new/refurbished building).
- Carry out wireless heat map off plan
- Produce wireless heat map to ensure coverage of wireless signal throughout the whole building envelope. This shall include pre-construction predictive modelling, and post-construction measured survey results. The parameters for the predictive modelling are presented in Appendix E.
- Labelling of all installed circuits
- Physical installation of wireless access points
- Compliance of wireless works with University specification for WIFI provision
- Complete post installation wireless heat map survey
- Caplum audit for installed circuits
- Services in hub rooms
 - Provide power from a dedicated single outlet (not a fused spur) to each power distribution block. The socket shall be secured in such a way that the plug top cannot be casually removed or switched off (e.g. located in a secure enclosure or mounted out of normal reach).
 - Provide air conditioning (cooling) to counteract the heat produced by the equipment in the rack: for reasons of access and ensuring that condensate cannot enter the equipment rack, the air conditioning shall **not** be located above the rack.
 - Provide lighting for safe working in the equipment rack. If the room has no windows then an emergency light fitting is to be provided.
 - Provide fire detection associated with the building system for remote fire monitoring.
 - Provide containment within each hub room to accommodate the structured and fibre optic cabling.

- Provide earth terminal point for connection of equipment rack to building earth system.
- Cable Pathways
 - Provide a comprehensive distribution network of cable pathways radiating from each data equipment room to conduct individual service cables to their rooms. **The distribution must be accessible throughout its length to facilitate installation of additional circuits and to enable fault investigation.** Within the rooms provide trunking with separate lids for mains and structured cabling.
 - Provide cable pathway from the building distributor (hub room) to the cable entry point of the new building.
 - All pathways must maintain adequate separation from sources of electrical interference. Extensive guidance on pathway design is provided in the standards.
- Equipment Racks
 - Provide and install all racks.
- Structured Cabling
 - Provide, install and terminate all structured cables (including cables for Access control, BMS and any other services that are expected to run on the University's data network). These cables start at the destination office where they are terminated in an RJ45 faceplate. At the rack all cables are to be terminated on RJ45 patch panels. Cables to be tested with tester that is certified for testing the installed cabling and the results supplied to iSolutions. Circuits are to be labelled at both ends in accordance with iSolutions standard.
- Building Distribution (BD) Fibre Optic
 - The Data Contractor shall install, terminate and test all BD fibre optic cables.
- Campus Distribution (CD) Fibre Optic
 - The Data Contractor shall install, terminate and test all CD fibre optic cables.
 - Supply and patch and label all copper and fibre installed circuits.
 - Design, supply, installation and commissioning of a building wide Emergency Voice Communication system in compliance with UOS issued specifications.
- **All works in strict compliance with the university IT and cabling specifications issued.**

9.2.3 Estates & Facilities

- Ensure information regarding:
 - Access Control
 - BMS
 - CCTV
 - Emergency lighting
 and any other device that needs a connection to the data network is passed to the project leader and iSolutions.
- Support of Access control and BMS is not provided until after building handover, due to the fact that iSolutions need to install the active equipment that connects to the University's data network. If Access control and BMS are required before building handover, the following items need to be completed.
 - The building distributor (hub room) needs to be in a completed state with all structured cabling and fibre links external to the building installed and tested. This must include the data cables to the Access and BMS controllers.
 - iSolutions staff must be able to get access to the hub room to install power on the active equipment and link it to the University's data network.
 - Once the active equipment has been installed and switched on there shall be no interruptions to the mains power supply feeding the rack.
 - iSolutions will notify the type and number of lock to be fitted to doors

- The hub room shall be in a clean sterile state with all works completed.
- To determine the number and location of DDA refuge call phones throughout the building.
- To determine the number and location of public emergency and lift phones throughout the building.

9.2.4 iSolutions

- iSolutions will issue all IT specifications.
 - iSolutions will approve the design, the cable and components for the structured cabling system that has been proposed.
 - iSolutions will review and comment on the high and low level designs issued by the main contractor and approve if compliant with the issued university specifications.
- Design of Data and VOIP Installation
 - iSolutions will design the Data and VOIP installations at the service level for the new building. All proposed outlets will be fully activated.

10 Documentation

10.1 Project Start-Up and Specification

Documentation requirements from the University.

- [NA Mandate](#)
- [NA Design Principles](#)
- [NA Fibre Highfield Concept Plan](#)
- [NA Core Architecture Concept Plan](#)
- [NA Edge Switches and fibre.xlsx](#)
- [Agreed Labelling Scheme](#)
- [University of Southampton Specification \(15.0\).docx](#)
- Additional requirements: B48, Physics

10.2 As Built Documentation

Three sets of hand over documentation shall be submitted 2 weeks after practical completion has been granted by the university. The documents shall be in hardcopy and electronic format and include:

10.2.1 Documentation from Data contractor

- Prior to construction:
 - Design submission
- As constructed drawings of the internal and external installations:
 - Cabinet layouts to include all fibre and copper patch panels along with labelling of patch panels and ports
 - Building floor plans in AutoCAD to show all TO positions with port numbers, containment routes and sizes, telecom rooms, cabinet locations, building entry points, internal Building backbone routes between MER and SER etc
 - Site plans in AutoCAD to show external Campus backbone cable routes between DERs, and spurs to MERs etc
- Data formatted ready for load into Caplum (a template can be provided) showing relationship and connectivity of:
 - Cables, Pits, Buildings, BEPs, DAs
 - TDUs, Gas Seals
 - Racks, Panels, U positions
 - Tubes, Fibre bundles, Panels, ports
 - Labels applied to all components
- Fibre Optic test results – OTDR and power meter at both wavelengths
- Copper test results – CSV format for all installed permanent links
- Fibre and copper test results are presented before go live and after telecom room sign off/handover to allow go live to take place with a go live change.
- Inventory of components used including tubes, fibre, joints, labelling and terminations
- Health and Safety file
- Patching records for all fibre and copper patch leads
 - Service type, PoE, 10 Base T etc
 - Outlet number
 - Distribution and terminal patch panel number
 - Distribution and terminal patch panel port number
 - Switch and port number
 - Room number

- Room location
- Spare capacity statement (including stubs or other elements put in place for later expansion)
- Thresholds
 - % Use of fibre bundles.
 - % Use of tubes
 - % Use of internal tray capacity
 - % Use of external duct capacity / BEP

10.2.2 Documentation from fibre Contractor

- Fibre Optic inspection results
- Warranty

10.2.3 Documentation from Civil or Buildings contractor

- Duct construction design
- Site duct routes marked onto Estates AutoCAD plans
- Building Entry Point construction

10.3 Electronic Recording

The University requires that all fibre and copper infrastructure installed as part of a structured cabling system as specified in this document is recorded in the University's management toolset Caplum. This includes:

- Campus Backbone cabling subsystem
- Building Backbone cabling subsystem
- Horizontal Cabling subsystem
- Other system components as are necessary to properly populate the management toolset

10.3.1 Major new installations by an externally Appointed Data Contractor

For all new installations, the Data Contractor must provide a documentation pack at a minimum conformant with the requirements of section 9. This will include the information that is needed to populate the management toolset. The data shall be loaded into Caplum by the Contractor and presented to iSolutions before project completion.

The data entered into Caplum shall be audited by the University approved contractor below:

Ardlin Systems Limited, Unit 3B, East Throp House, 1,Paddock Rd, Reading. RG4 5BY. Tel.0118 956 0355.

Contact: Mr Simon Holland.
 Email, S.Holland@soton.ac.uk
 Mobile. 07966 291020.
 Web address www.ardlin.net

Ardlin Management Team:
 Richard Bone. Managing Director.
 Simon Watson. R&D Director.
 Simon Holland. Technical Supervisor.

Where information is found to be missing, incomplete, or subject to discrepancy, an audit will need to be carried out before the data can be successfully loaded into the management toolset.

The University approved contractor named above shall be used for this audit and recording exercise.

It is the responsibility of the University Client representative or Project Manager to ensure funds are allocated for completing this mandatory work, following practical completion.

11 Standards

11.1 Standards

All stated standards shall be adhered to, but not limited to, where applicable. In the case of conflict between standards the most onerous standard shall be adhered to for the individual section under discussion.

11.1.1 British Standards Institute

- BS 6701:2016:+A1:2017 Telecommunications equipment and telecommunications cabling. Specification for installation, operation and maintenance
- BS 7671:2018 18th Edition Requirements for Electrical Installations. IET Wiring Regulations
- BS 5328: Part 1:1997 Guide to specifying concrete including AMD 7174, July 1992
- BS 5328: Part 2:1997 Methods for specifying concrete mixes including AMD 7174, July 1992
- BS 6031 Code of Practice for Earth Works.
- BS EN 50626-1. Conduit systems buried underground for the protection and management of insulated electrical cables or communication cables. Part 1. General requirements.

11.1.2 Cenelec

- BS EN 50173-1:2011 Information technology. Generic cabling systems. General requirements
- BS EN 50173-2:2007 + A1:2010 Information technology. Generic cabling systems. Office premises
- BS EN 50173-3: 2007 + A1:2010 Information technology. Generic cabling systems. Industrial premises
- BS EN 50173-5: 2007+A2:2012 Information technology. Generic cabling systems. Data centres
- BS EN 50173-6:2013 Information technology. Generic cabling systems. Distributed building services
- BS EN 50174-1: 2009+A2:2014 Information technology. Cabling installation. Installation specification and quality assurance
- BS EN 50174-2: 2009+A2:2014 Information technology. Cabling installation. Installation planning and practices inside build
- BS EN 50174-3:2013 Information technology. Cabling installation. Installation planning and practices outside buildings

- BS EN 50346:2002+A2:2009 Information technology. Cabling installation. Testing of installed cabling
- BS EN 50310: 2016 Application of equipotential bonding and earthing in buildings with information technology equipment
- BS EN 61537:2007 Cable management. Cable tray systems and cable ladder systems

11.1.3 IEC

Draft IEC 61156 – Category 6 cables

Draft IEC 60607-3-4-5 - Category 6 connectors

IEC 61935-1-2 - Testing of installed cable

11.1.4 Miscellaneous

- British Telecommunications PLC Specification LN 550 (Issue 9)
- Control of Asbestos at Regulations 2012. Contractors should note that in the event of suspected discoveries of Asbestos, work must stop immediately and the concern reported.
- COSHH Regulations 2015.
- DISC PD 1001 A Guide to Electromagnetic Compatibility & Structured Cabling.
- HAUC Code of Practice for reinstatement in the public Highways
- Health & Safety “Avoiding Danger from Underground Services HS (G) 47
- Highways act 1980
- Local Authority Regulations 2015
- NJUG 04 Identification of small underground services.
- NJUG 07 Positioning of utilities mains and plant for new works.
- NJUG 10 Guidelines for the planning, Installation and Call Out of Utilities Services in the proximity of trees.
- RIDDOR: Reporting of injuries, Diseases and Dangerous Occurrences Regulations 2013.
- Safety at Street Works and Road Works - A code of practice.
- CLP Regulation
- EPA 1990
- EAW 1989

- Health and Safety at Work etc. Acts 1974 (HSAW) including but not limited to:
 - Management of Health and Safety at Work Regulations 1999
 - Workplace (Health, Safety and Welfare) Regulations 1992
 - Provision and Use of Work Equipment Regulations 1998
 - Personal Protective Equipment at Work Regulations 1992
 - Manual Handling Operations Regulations 1992
 - Construction (Design and Management) Regulations 2015

12 Component Specification

12.1 General

The specification for the major elements comprising the structured cabling solution shall be defined below. Products shall be fully compliant to all requested standards for all parameters.

12.2 Copper Cables

All copper cables contained within the scope of the structured cabling shall be constructed of 4 pair Category 6a, and be compliant to component specification to ISO/IEC 11801:2002, EN 50173:2002 and TIA/EIA 568-B.2-1. Please reference the tender documentation for the category performance.

The product sets shall be as follows:

12.2.1 CommScope– Cat 6a Cca

CopperTen Category 6a 4PR F/FTP Horizontal Cable

The CommScope F/FTP 4PR cable is designed for applications up to 500 MHz and its connection properties exceed Category 6a specifications ISO/IEC 11801 and EN50173-1



Description	Sheath	Colour	Part No.
F/FTP 4pr Cat 6a (500m)	Cca	White	884035958/16

12.2.2 Telecom cables

1308FLH Telecoms Cable

Comtec standard telecoms grade cable is used for low speed voice and data transmission. It comes in 1 to 100 pairs and is over sheathed to provide a LSOH cable.

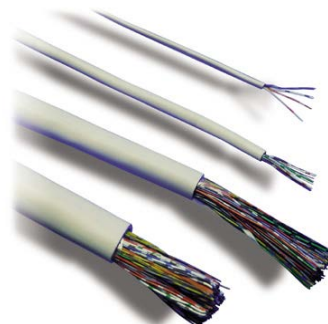

Description	Sheath	Colour	Part No.
LSOH telecoms cable, 1 to 100prs	LSOH	Grey	Contact Comtec

12.3 Copper Jacks and Patch Panels

All copper jacks contained within the scope of the structured cabling shall be constructed of 4 pair Category 6 and Category 6a RJ45's and be compliant to component specification to ISO/IEC 603-7-8, ISO/IEC 11801:2002, EN 50173:2002 and TIA/EIA 568-B.2-1.

The product sets shall be as follows:

12.3.1 CommScope– Cat 6a

RJ45 Jacks for Use at the Telecomms Outlet End - CAT 6A SLX Shielded SL Jack 180 Deg



Category 6A performance jack. Adapters and faceplates to be purchased separately.

Description	Pack Qty	Colour	Part No.
Cat 6A jack shielded	1	Silver	2153449-2

Adapters

Range of adapters to suit different faceplates. Purchase jacks and faceplates separately.



Description	Pack Qty	Colour	Part No.
Single shuttered angled 25x50mm module	1	Signal White	65401802-00

Faceplates

Euro style faceplate 25x50mm faceplate



Description	Pack Qty	Colour	Part No.
Faceplate Double BS 50mm unpopulated	1	White	1711399-1

Faceplate Quad BS 50mm unpopulated	1	White	1711400-1
------------------------------------	---	-------	-----------

RJ45 Jacks for Use at the Patch Panel End - CAT 6A SLX Shielded SL Jack 180 Deg



Category 6A performance jack. Adapters and faceplates to be purchased separately.

Description	Pack Qty	Colour	Part No.
Cat 6A jack shielded	1	Silver	2153449-2

Shielded CAT 6/6A Patch Panel

High density 19" 1U Category 6/6A straight performance shielded patch panel. Supplied without jacks. Integral cable management and labelling field.



Description	Pack Qty	Colour	Part No.
24 port unloaded quick fit patch panel	1	Black	760237046
Saddle and Velcro strap kit	1	Silver	760229179

TrueNet® RJ45 Cat 6 and 6a UTP and shielded MiniPod

Designed to help simplify the cabling of raised floor work spaces and is ideal for high density environments. Exceeds specifications according to ISO/IEC 11801:2002, EN 50173-1:2002 and TIA/EIA 568-B



Note: 6 Way shown. 4 Way supplied with two blanks to allow for future expansion

Description	Pack Qty	Colour	Part No.
MiniPod, 6 way unpopulated (to be used for Cat 6a shielded) – includes 6 adapters but no jacks	1	Black	2153217-6
MiniPod, 4 way unpopulated (to be used for Cat 6a shielded) – includes 4 adapters, 2 blanks but no jacks	1	Black	2153217-4
MiniPod, 3 way unpopulated (to be used for Cat 6a shielded) – includes 3 adapters but no jacks	1	Black	2153216-3
MiniPod, Category 6 CL UTP, 4 Port	1	Black	6540 1 678-04
MiniPod, Category 6 CL UTP, 6 Port	1	Black	6540 1 678-06

32mm Cable Gland	Not available from CommScope. Glands available from CommScope distributors or other cable management supplier.
------------------	--

12.4 Copper Patch Leads

All copper patch leads contained within the scope of the structured cabling shall be constructed of 4 pair Category 6 or 6a and be compliant to component specification to ISO/IEC 11801:2002, EN 50173:2002 and TIA/EIA 568-B.2-1. The patch leads shall be booted.

The product sets shall be as follows:

12.4.1 CommScope– Cat 6a

<p>Shielded 6a Patch Leads</p> <p>Range of Category 6 and 6a patch leads available in various cable types and lengths.</p>	
Cat 6a patch cord 0.5m S/FTP LSOH	NPC6ASZDB-WT050M
Cat 6a patch cord 1m S/FTP LSOH	NPC6ASZDB-WT001M
Cat 6a patch cord 2m S/FTP LSOH	NPC6ASZDB-WT002M
Cat 6a patch cord 3m S/FTP LSOH	NPC6ASZDB-WT003M
Cat 6a patch cord 5m S/FTP LSOH	NPC6ASZDB-WT005M

12.5 Fibre Cables and Tubes

All fibre cables contained within the scope of the structured cabling shall be constructed of 50/125µm (multimode) and 8/125µm (singlemode) and be compliant to component specification to ISO/IEC 11801:2002, EN 50173:2002 and TIA/EIA 568-B.2-1.

Fibre cables, for the purposes of this tender, shall be defined by cable type and whether internal or external to a building. Where a cable run is internal to a building tight buffered cable shall be used. This allows vertical runs between floors to be installed without the specialised strain relief required by loose tube.

The product sets shall be as follows:

12.5.1 CommScope– Tight Buffered: recommended for internal applications

Tight Buffered Fibre Cable

4, 8, 12, 16 or 24 fibre multimode and singlemode distribution cable. Tight buffered, internal/external grade.

NB – For the purposes of this tender this cable shall be used **INTERNAL** to buildings.

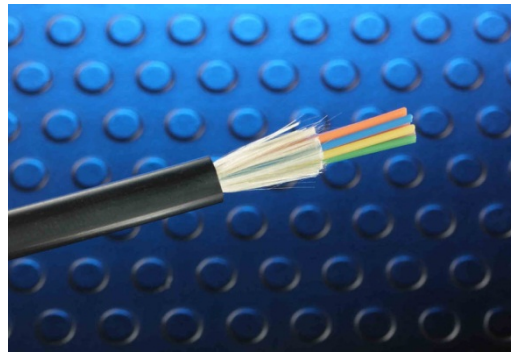

Description	4 Fibre	8 Fibre	12 Fibre
9/125µm	N/A	7023/3/228/08	N/A
Description	16 Fibre	24 Fibre	48 Fibre
9/125µm	N/A	N/A	N/A

12.5.2 CommScope– Loose Tube: recommended for external applications

Loose Tube Fibre Cable

4, 8, 12, 16 or 24 fibre multimode and singlemode distribution cable. Loose tube, internal/external grade.

NB – For the purposes of this tender this cable shall be used **EXTERNAL** to buildings.

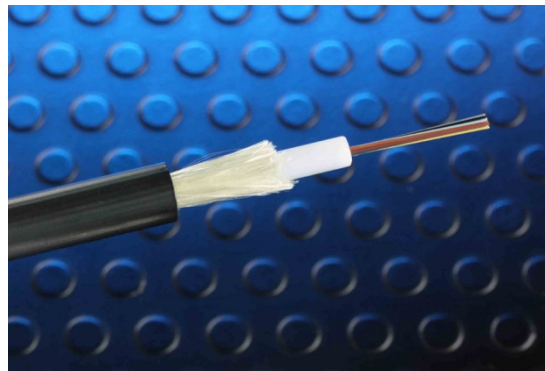

Description	4 Fibre	8 Fibre	12 Fibre
9/125µm	N/A	N/A	N/A
Description	16 Fibre	24 Fibre	48 Fibre
9/125µm	N/A	N/A	7023/3/224/48

12.6 Fibre Cables

All fibre cables contained within the scope of the structured cabling shall be constructed of 9/125µm OS2 (single mode) or 50/125µm OM4 (multimode) and be compliant to component specification to ISO/IEC 11801:2002.

Fibre cables, for the purposes of this tender, shall be defined by cable type and whether internal or external to a building.

The product set shall be as follows:

12.6.1 CommScope– Blown Fibre

Blown Fibre OS2 4, 8 and 12 Core

4, 8 and 12 core OS2 grade 9/125 multimode blown fibre cable. Typical blowing distances of 1000m.

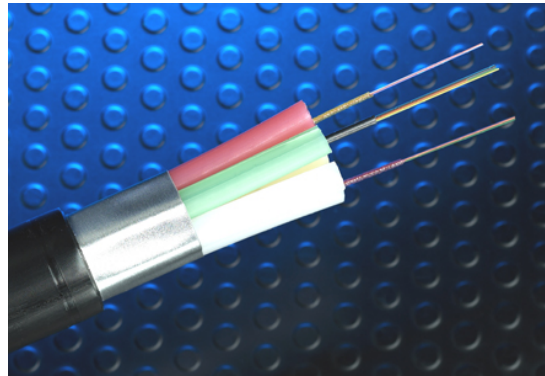

6	8 core OS2 blown fibre cable	2000m		
7	12 core OS2 blown fibre cable	2000m		

12.6.2 CommScope– Blown Fibre Tube

Blown Fibre Tubing

1, 2, 4, 7, and 19 way Blown Fibre Tubing. Available in LSOH, PVC, direct install (ducting) and direct buried.

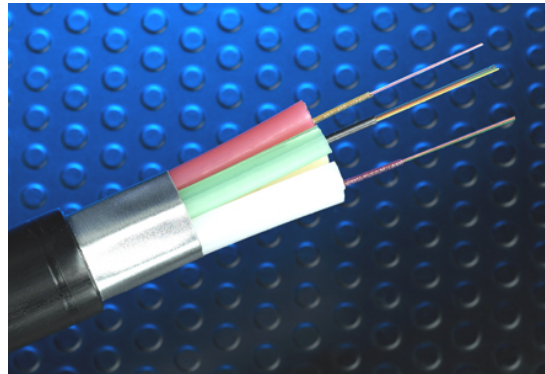

Direct Install 4 way blown fibre tube	2000m	Black	
Direct Install 4 way blown fibre tube	1000m	Black	
Direct Install 4 way blown fibre tube	500m	Black	
Direct Install 7 way blown fibre tube	2000m	Black	
Direct Install 7 way blown fibre tube	1000m	Black	
Direct Install 4 way blown fibre tube	500m	Black	
LSOH 2 way blown fibre tube	500m	Grey	
LSOH 4 way blown fibre tube	500m	Grey	
LSOH 7 way blown fibre tube	500m	Grey	

12.7 Accessories

The product set shall be as follows:

12.7.1 CommScope – Blown Fibre accessories

Blown Fibre Accessories

A range of blown fibre tubing connectors and caps for internal and external use.



Description	Pack Qty	Part No.
Tube connector 5-5mm	10	7032/1/400/76
End cap 5mm	10	7032/1/400/72
Gas seal connector 5-5mm	10	
Tube sealing cap 5mm	10	7032/1/223/00
Reducer connector 8-5mm	10	7032/1/400/75

Customer Lead In Unit

Enables external cable to pass through the building fabric from an outside wall. Comprises of two separate units, an external and internal, connected by a length of conduit.



Description	Pack Qty	Part No.
Customer Lead In Unit	1	7032/1/400/85

Gas Seal Unit

Seals external blown fibre tubing and acts as a demarcation between internal and external tubing. Positioned internal to the building at the tubing entry point.



Description	Pack Qty	Part No.
Gas Seal Unit	1	7032/1/400/86

Internal Distribution Unit

Used for the distribution and jointing of blown fibre tubing internal to a building.



Description	Pack Qty	Part No.
Internal distribution unit	1	7032/1/401/50

The cable sheath shall be constructed of LSOH material. The construction shall be tight buffered or loose tube and of internal/external grade. Cables running external shall use the existing ducting system, which cannot be guaranteed to be water or gas tight. It is required that the cable be specified for total immersion in water for lengthy periods of time and still meet the warranty period requested.

12.8 Fibre Jacks

All fibre jacks contained within the scope of the structured cabling shall be constructed of 50/125µm (multimode) and 9/125µm (singlemode) and be compliant to component specification to ISO/IEC 11801:2002, EN 50173:2002 and TIA/EIA 568-B.2-1. The jack should be SC duplex construction with pigtail ferrules; direct termination is not an option for this tender. The quality of pigtail polishing shall be PC for multimode and UPC for singlemode.

The product sets shall be as follows:

<p>Split Metal Patch Panel</p> <p>1U Metal patch panel with 2 off horizontal draws loaded with adapters</p>	
<p>Description</p>	<p>Part No.</p>
<p>LC multimode</p>	<p>7033 1 015-02</p>
<p>LC singlemode</p>	<p>7033 1 015-01</p>

12.9 Fibre Patchcords and Pigtails

The product sets shall be as follows:

<p>LC to LC OM3</p>	 <p>13</p>
<p>Description</p>	<p>Part No.</p>
<p>1m LC to LC patch cord OM3</p>	<p>6536969-1</p>
<p>2m LC to LC patch cord OM3</p>	<p>6536969-2</p>
<p>3m LC to LC patch cord OM3</p>	<p>6536969-3</p>

<p>LC to LC OS2</p>	 <p>20</p>
<p>Description</p>	<p>Part No.</p>
<p>1m LC to LC patch cord OS2</p>	<p>6536501-1</p>
<p>2m LC to LC patch cord OS2</p>	<p>6536501-2</p>
<p>3m LC to LC patch cord OS2</p>	<p>6536501-3</p>

<p>Pigtails</p>	<p>27</p> 
<p>Description</p>	<p>Part No.</p>
<p>1m LC OS2 pigtail semi-tight</p>	<p>6536880-1</p>
<p>1m LC OM3 pigtail semi-tight</p>	<p>6536966-1</p>

12.10 Voice Boxes

All telecommunication box connections shall be manufactured by CommScope.

The product sets shall be as follows:

Connection Box 200 Series

Plastic modular box, designed to accommodate 30, 50 and 70 pairs. Suitable for use with protection magazine and ComProtect over voltage protection.

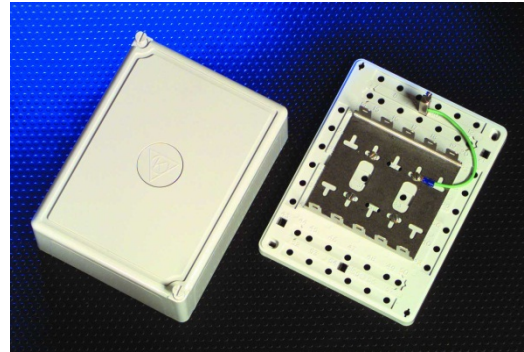

Description	Qty	Dimensions	Part No.
32 220 Box for 3 LSA-PLUS® 10 pair modules	1	170(H)x120(W)x80(D)	6429/1/073/01
250/5 Box for 5 LSA-PLUS® 10 pair modules	1	210(H)x160(W)x90(D)	6525/1/022/00
250/7 Box for 7 LSA-PLUS® 10 pair modules	1	210(H)x160(W)x90(D)	6525/1/024/00

Connection Box 300 Series

Plastic modular box, designed to accommodate 100 and 250 pairs. Suitable for use with protection magazine and ComProtect over voltage protection.

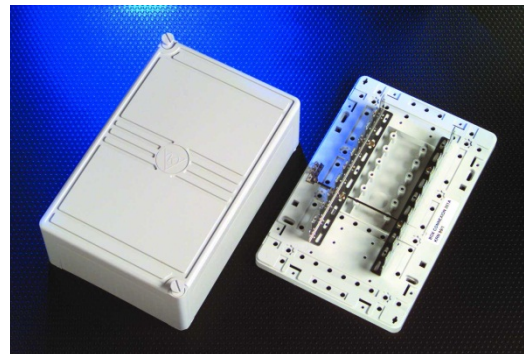

Description	Qty	Dimensions	Part No.
301A Box for 10 LSA-PLUS® 10 pair modules	1	320(H)x210(W)x120(D)	6530/1/017/00
300 Box for 25 LSA-PLUS® 10 pair modules	1	640(H)x210(W)x120(D)	6428/1/290/00

Connection Box 500 Series

Plastic modular box, designed to accommodate 340, 680, 1020 and 1360 pairs. Suitable for use with protection magazine and ComProtect over voltage protection.



Description	Qty	Dimensions	Part No.
510 Box for 34 LSA-PLUS® 10 pair modules	1	1000(H)x300(W)x130(D)	6532/2/009/00
520 Box for 68 LSA-PLUS® 10 pair modules	1	1000(H)x500(W)x130(D)	6532/2/010/00
530 Box for 102 LSA-PLUS® 10 pair modules	1	1000(H)x750(W)x130(D)	6532/2/011/00
540 Box for 136 LSA-PLUS® 10 pair modules	1	1000(H)x1000(W)x135(D)	6532/2/008/00

12.11 Voice 237 Modules

All telecommunication 237 modules shall be manufactured by CommScope.

The product sets shall be as follows:

Disconnection Module

10 pair LSA-PLUS® modules which contain two piece contacts normally closed. Has advantage of individual pair disconnection and four wire test access.

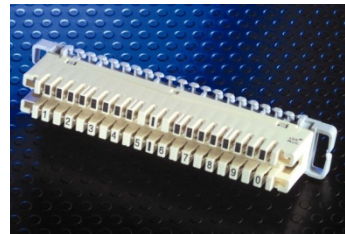

Description	Pack Qty	Colour	Part No.
10 pair disconnection contacts	10	Cream	6089/1/810/00
10 pair disconnection contacts	10	Green	6089/1/811/00
10 pair disconnection contacts	10	Blue	6089/1/812/00

Earth Module

LSA-PLUS® modules with a one piece contact and earthing rail accommodating up to 2 identical wires per slot.

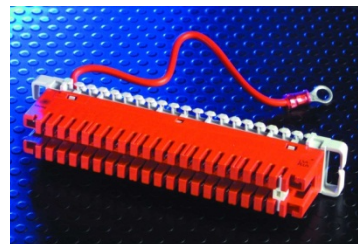

Description	Pack Qty	Colour	Part No.
76 way, earth lead and terminal ring	10	Red	6089/1/840/00
20 way, earth lead and terminal ring	10	Green	6089/1/841/00

12.12 Voice 10 Pair Label Holders and Labels

All telecommunication label holders shall be manufactured by CommScope.

The product sets shall be as follows:

LSA-PLUS® Label Holder

Label holders for mounting on 10 pair LSA-PLUS® modules. No need to remove when using test plugs or inserting jumper wires. Labels can be ordered separately.

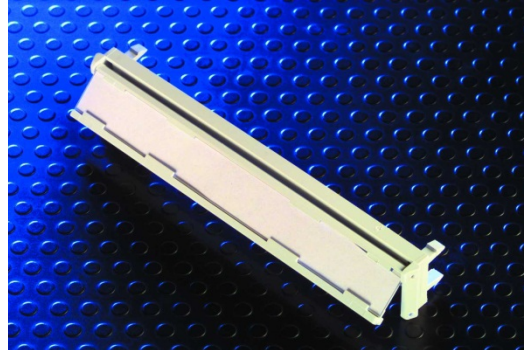

Description	Pack Qty	Colour	Part No.
Double sided hinged label holder	10	Grey	6092/1/810/00
Double sided hinged label holder	10	Green	6092/1/811/00
Double sided hinged label holder	10	Blue	6092/1/812/00

Backmount Label Holder

Label holders for mounting directly onto backmount frames. Used to identify blocks of LSA-PLUS® modules fed by specific cables and or buildings, floor areas, etc.

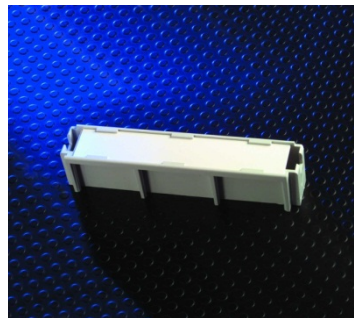

Description	Pack Qty	Colour	Part No.
Label holder complete with label, fits on one position on backmount frame	10	Grey	6092/1/820/00

Vertical Label Holder

Label holders for mounting directly onto backmount frames. Used to identify a vertical backmount. Must be positioned at the top or bottom of the frame.

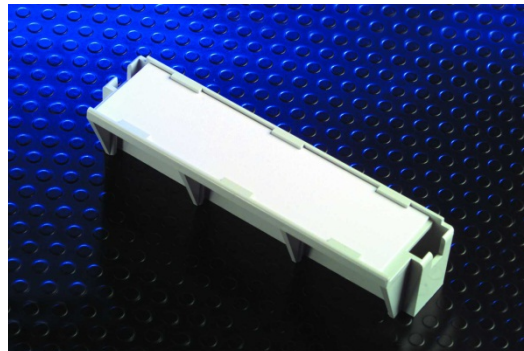

Description	Pack Qty	Colour	Part No.
Label holder complete with label, fits on one position on backmount frame	100	Grey	6092/1/830/00

12.13 Lightning Protection

All telecommunication lightning protectors shall be manufactured by CommScope.

The product sets shall be as follows:

Pole Arrester

3 pole over voltage arresters.



Description	Pack Qty	Part No.
200V-5A/5KA with failsafe 21A.	100	6535/1/010/00

Protector Magazine

For 3 pole over voltage arresters, plugs into LSA-PLUS disconnection and connection modules.

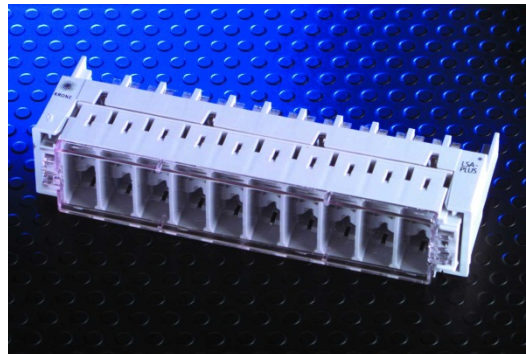

Description	Pack Qty	Part No.
10 pair, fitted with clear cover magazine.	10	6535/1/010/00

12.14 Converters

All telecommunication converters shall be manufactured by CommScope.

The product sets shall be as follows:

Outlet Converters

Converters enable telecommunications equipment fitted with standard BT phone plugs to be connected to RJ45 based structured cabling systems.

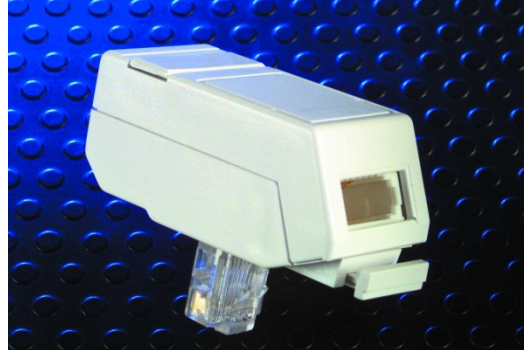

Description	Pack Qty	Part No.
Standard 258A PABX master	10	6536/1/601/16
Standard 258A secondary	10	6536/1/601/18

Flying Lead Outlet Converters

Converters enable telecommunications equipment fitted with standard BT phone plugs to be connected to RJ45 based structured cabling systems.



Description	Pack Qty	Part No.
Flying lead 258A PABX master	10	6536/1/601/10
Flying lead 258A secondary	10	6536/1/601/12

12.15 Frames/Cabinets

Frames are required unless shared occupation applies.

All frames shall be Ortronics Mighty Mo 20

The product set will be as follows:



12.16 Powered Fibre Cable

All powered fibre cable shall be manufactured by CommScope.

The product sets shall be as follows:

Fibre cable

OS2 fibre cable with 12AWG DC power copper cores



Description	Sheath	Part No.
PFC, singlemode, 2F, I/O, 12AWG	Cca	PFC-S02L12
PFC, singlemode, 4F, I/O, 12AWG	Cca	PFC-S04L12
PFC, singlemode, 12F, I/O, 12AWG	Cca	PFC-S12L12
PFC, OM3, 2F, I/O, 12AWG	Cca	PFC-302L12
PFC, OM3, 4F, I/O, 12AWG	Cca	PFC-304L12

Power Supplies

57VDC Power Supply for use with Powered Fibre Cable System



Description	Part No.
Power Express Distribution shelf with alarm module	PFP-PX-S1
Power Express Distribution module supports max. 8 Devices	PFP-PX-8M
Power Express Blank Slot Panel	PFP-PX-SF
SPS Rectifier Power Distribution Shelf	PFP-SPS-S1
1600W SPS Power Rectifier module	PFP-SPS-1600M
SPS Rectifier Controller Display	PFP-SPS-C1
SPS Rectifier Blank Slot Panel	PFP-SPS-SF

Power over Ethernet (PoE) Extenders

Enhances the Powered Fiber Cable System by allowing 2 PoE or PoE+ devices to be connected via one hybrid cable



PFU-P-C-O-060-02

Description	Part No.
PoE Extender with Aruba Bracket	PFU-P-A-O-030-01
PoE Extender with Wall/Pole Mounting Bracket	PFU-P-B-O-030-01
2-Port PoE Extender	PFU-P-C-O-060-02

60W Single Port PoE Extender	PFU-P-C-O-060-01
------------------------------	------------------

Power Extenders

Provide the same power management and electrical protection benefits of the PoE Extenders. Designed to handle devices which require direct fiber input and DC power.



PFU-48-C-O-060-01

Description	Part No.
Power Extender with 48VDC output	PFU-48-C-O-060-01
Power Extender with 12VDC output	PFU-12-C-O-060-01

Appendix A Fibre Inspection and Cleaning

A.1 Warnings

- Turn off lasers sources prior to inspection and cleaning
- Ensure that the patch lead or link is disconnected at both ends
- Wear appropriate fibre safety glasses that are matched to the laser source
- Never use alcohol around spark sources or open flames
- Never look into a fibre connector/plug while the system lasers are on
- Never clean a fibre connector/plug without a means of inspection
- Never use unfiltered inspection magnifiers
- Never touch the face of fibre connectors and plugs
- Never reuse the same section on a cleaning cassette or a cleaning tissue
- Never touch the cleaning surface of a tissue or cassette
- Never touch the dispensing bowl of an alcohol bottle

A.2 Inspection

1. Ensure that all lasers sources are turned off
2. Ensure that the link or patch lead is disconnected at both ends
3. Remove the protective cap and store in a clean resealable container
4. Ensure that the magnifier has the same connector type as the patch lead or link to be inspected
5. Insert the fibre plug into the magnifier and adjust the focus to provide a clear image of the fibre face
6. Check for contaminants and scratches to the requirements of IEC 61300-3-35. Section A6 shows some typical examples of contaminations.
7. If required clean the plug as detailed in section A3 below and repeat steps 1 to 7 as many times as required to remove contaminants
8. Immediately replace the end cap or plug into the equipment

A.3 Dry Cleaning with Cartridge or Card Based Products

1. Ensure that all lasers sources are turned off

2. Ensure that the link or patch lead is disconnected at both ends
3. Remove the protective cap and store in a clean resealable container
4. Select the type of dry cleaning device to be used i.e. automatic cartridge, manual cartridge, card/pocket cleaners
5. Ensure that the cleaning device has an unused surface showing
6. Hold the fibre face gently against the cleaning surface. For single core APC plugs rotate the plug by 90°. For multiple core plugs do not rotate. For APC plugs hold face at same angle as the cleaning surface
7. Slide the plug along the face of the cleaning area in the same direction as the arrow
8. For cartridge based cleaners ensure that the used surface is moved along
9. Repeat section A2 Inspection and if required steps 1 to 8 as many times as necessary

A.4 Dry Cleaning with Lint Free Wipes

1. Ensure that all laser sources are turned off
2. Ensure that the link or patch lead is disconnected at both ends
3. Remove the protective cap and store in a clean resealable container
4. Select an unused lint free wipe
5. Fold the wipe into a square of 4 to 8 layers thick
6. Ensure that the face of the wipe is not touched
7. Whilst holding the wipe gently swipe the plug onto the wipe in a figure of 8 motion
8. It is important to not press hard when swiping the wipe or scratches will occur
9. Expose another unused layer of the folded wipe and repeat steps 6 to 8
10. Dispose of the wipe
11. Repeat section A2 Inspection and if required steps 1 to 10 as many times as necessary

A.5 Wet Cleaning with Lint Free Wipes

1. If wet cleaning does not remove the contamination wet cleaning may be undertaken. Wet cleaning shall never be done prior to attempting to remove contamination by dry cleaning
2. Ensure that all laser sources are turned off
3. Ensure that the link or patch lead is disconnected at both ends
4. Remove the protective cap and store in a clean resealable container

5. Select an unused lint free wipe
6. Fold the wipe into a square of 4 to 8 layers thick
7. Ensure that the face of the wipe is not touched
8. Moisten one section of the wipe with 99% Isopropanol Alcohol ensuring that there is still a dry section available
9. Whilst holding the wipe gently swipe the plug onto the **WET** section of the wipe in a figure of 8 motion
10. Immediately after gently swipe the plug onto the **DRY** section of the wipe in a figure of 8 motion
11. It is important to not press hard when swiping the wipe or scratches will occur
12. Dispose of the wipe
13. Repeat section A2 Inspection and if required steps 1 to 12 as many times as necessary

A.6 Contamination Examples

1. Dust contamination

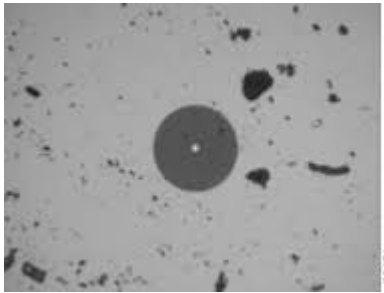

2. Liquid contamination

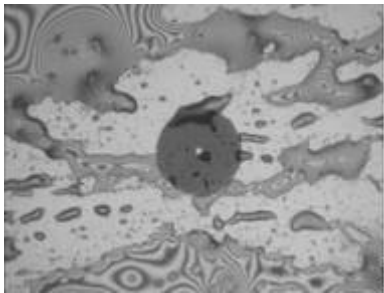
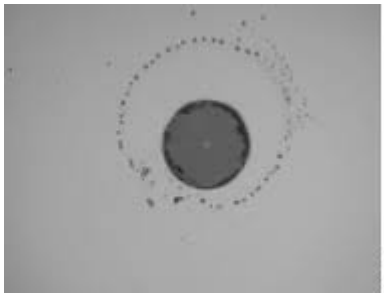
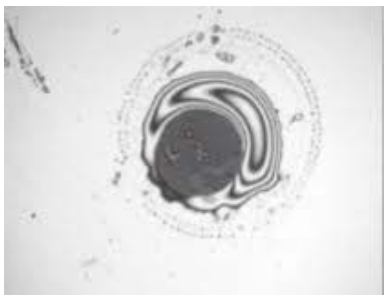

3. Dried residue

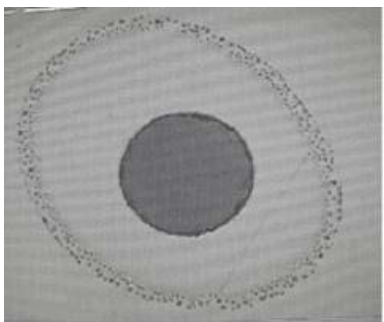

4. Alcohol residue

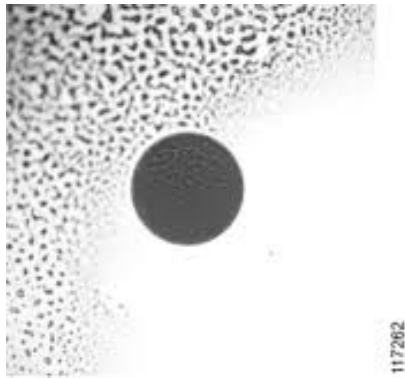

5. Chipped

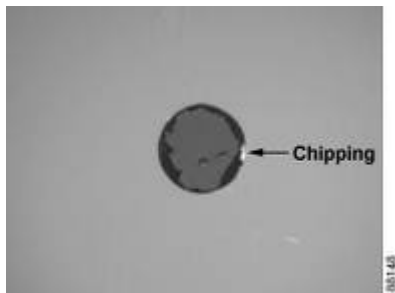

6. Scratched

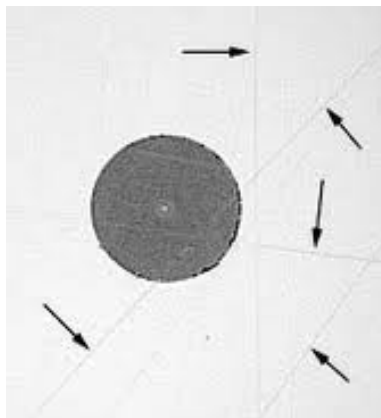

Appendix B Patching for Copper and Fibre

B.1 Copper Patch Panel Patching in Single Cabinets

1. The length of the patching route SHALL be measured, and a correct sized patch lead selected
2. The correct grade and type of patch lead SHALL be selected i.e. if the permanent link is category 6a F/FTP a category 6a F/FTP patch lead SHALL be used
3. Patch panel ports on the left-hand side (50% of total ports on the panel) SHALL be patched to the left-hand side of the patch panel
4. Patch panel ports on the right-hand side (50% of total ports on the panel) SHALL be patched to the right-hand side of the patch panel
5. The vertical cable management at the ends of the patch panels SHALL be used to contain the patch leads vertically

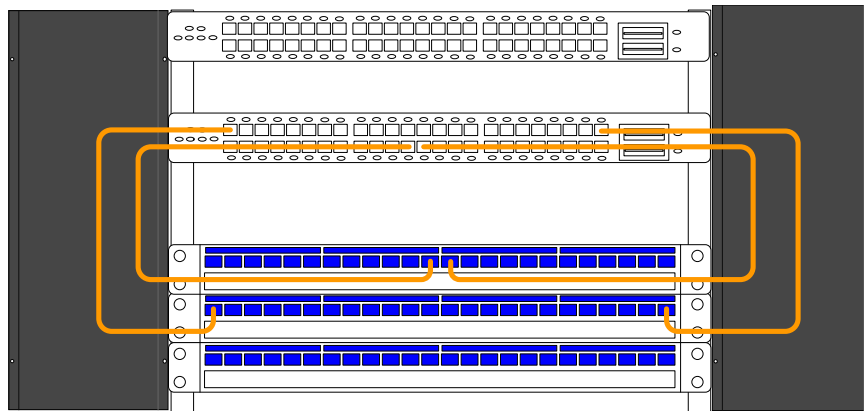

6. Vertical cable management SHALL be used. It is not acceptable to patch directly in front of the panels or to patch ports on the right-hand side of the panel to the left-hand side, and vice versa or to patch into the wrong horizontal cable management panel
7. Vertical cable management SHALL not be used to take up slack cable. The patch lead SHALL be the correct length



B.2 Copper Patch Panel Patching in Multiple Cabinets

1. The length of the patching route SHALL be measured, and a correct sized patch lead selected
2. The correct grade and type of patch lead SHALL be selected i.e. if the permanent link is category 6a F/FTP a category 6a F/FTP patch lead SHALL be used
3. All patch panel ports SHALL be patched to the right-hand side of the patch panel
4. The vertical cable management between the patch panel cabinet and the network switch cabinet SHALL be used to contain the patch leads vertically

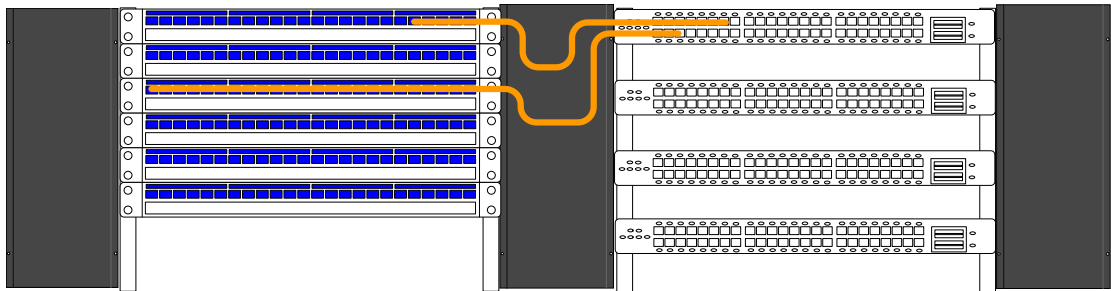

5. Vertical cable management SHALL be used. It is not acceptable to patch directly in front of vertical managers or to patch ports on the left-hand side vertical manager
6. Vertical cable management SHALL not be used to take up slack cable. The patch lead SHALL be the correct length

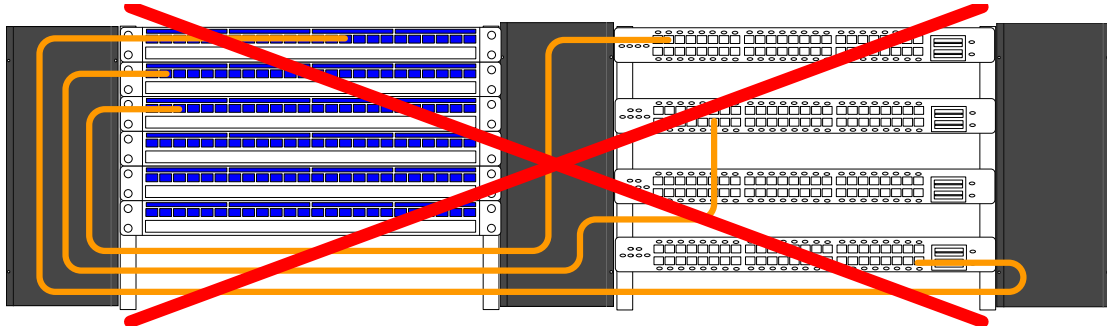

B.3 Fibre Split Patch Panel Patching

1. The length of the patching route SHALL be measured, and a correct sized patch lead selected
2. The correct grade of patch lead SHALL be selected i.e. if the link is OM3 an OM3 patch lead SHALL be used
3. Patch panel ports in the top drawer of the split fibre patch panel SHALL be patched to the right-hand side of the patch panel
4. Patch panel ports in the bottom drawer of the split fibre patch panel SHALL be patched to the right-hand side of the patch panel
5. Patch panel ports in the top drawer of the split fibre patch panel SHALL be patched into the horizontal cable management panel below the split fibre patch panel
6. Patch panel ports in the bottom drawer of the split fibre patch panel SHALL be patched into the horizontal cable management panel below the split fibre patch panel
7. The right-hand side vertical cable management SHALL be used to contain the patch leads vertically

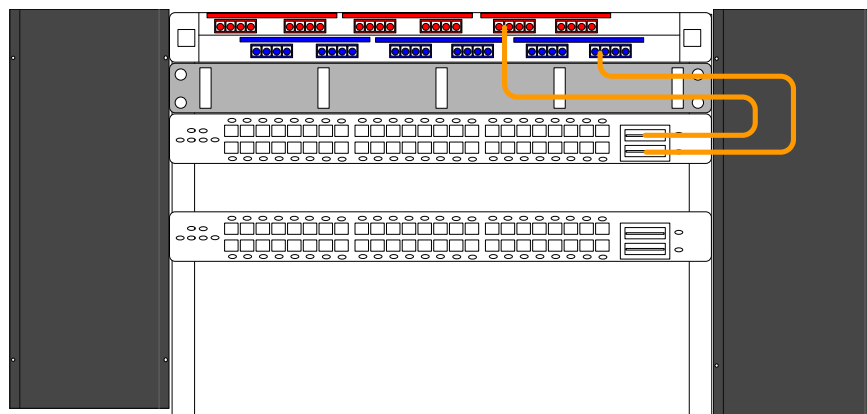

8. Horizontal and vertical cable management SHALL be used. It is not acceptable to patch directly in front of the panels or to patch ports on the left-hand side vertical cable manager

9. Horizontal and vertical cable management SHALL not be used to take up slack cable. The patch lead SHALL be the correct length

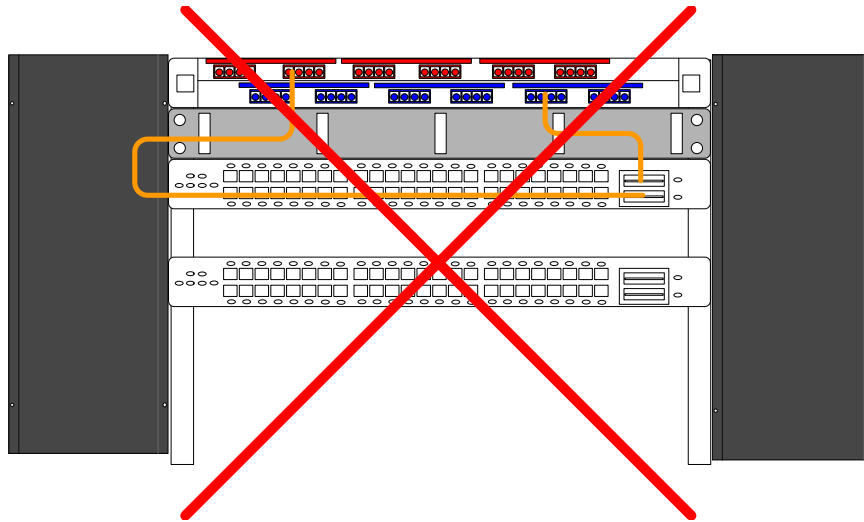

B.4 Fibre Patch Panel Patching

1. The length of the patching route SHALL be measured, and a correct sized patch lead selected
2. The correct grade of patch lead SHALL be selected i.e. if the link is OM3 an OM3 patch lead SHALL be used
3. All patch panel ports SHALL be patched to the right-hand side of the patch panel
4. The horizontal cable management panel below the fibre patch panel shall be used for the management of the patch leads
5. The vertical cable management at the right-hand side SHALL be used to contain the patch leads vertically

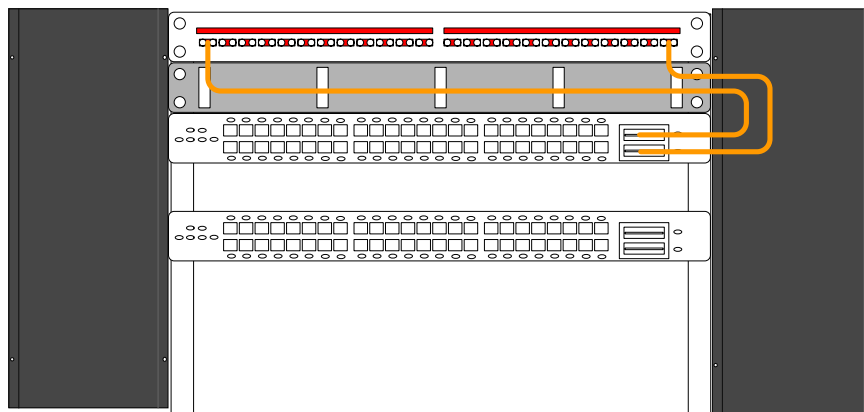

6. Horizontal and vertical cable management SHALL be used. It is not acceptable to patch directly in front of the panels or to patch ports on the left-hand vertical cable manager
7. Horizontal and vertical cable management SHALL not be used to take up slack cable. The patch lead SHALL be the correct length

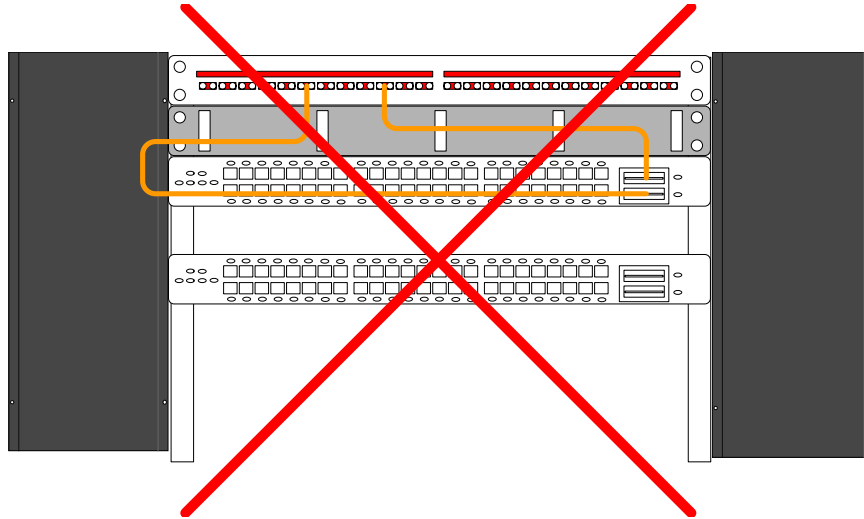

B.5 Mains Lead Patching

1. The main lead is patched from the PDUs to the switches
2. The mains leads from each PDU must be Velcro strapped together in no more than 24 mains leads. It is not acceptable to use cable ties
3. The bundles of cables MUST be supported on vertical cable management arms at no more than every 6U
4. Additional horizontal bars MUST be installed at the rear of each switch position and the mains leads for that switch MUST be Velcro tied to the bar
5. Where the mains lead is secured to the power module it shall have a loop that extends from the back of the module $\geq 100\text{mm}$ and $\leq 200\text{mm}$

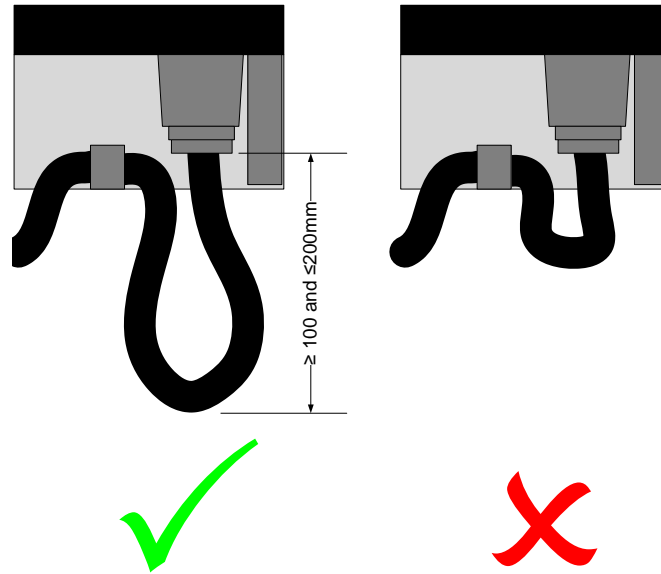

B.6 Patching Schedule

1. Below is an example of a patching schedule

Appendix C Labelling for Patch Panels, Minipods, Outlets, Cables and Blown Fibre Ducting

c.1 Type of Label

- The labels shall be self-adhesive engraved type
- In the UK the label type shall be Traffolyte for internal DP boxes, fibre and copper patch panels, Minipods
- The label type shall be Bradey for internal cables
- The label type shall be Critchley for external cables
- The font shall be Arial or Helvetica bold
- All text shall be centred vertically on the label
- All text shall be centred horizontally on the port, panel, faceplate etc.

c.2 Label Colour – Horizontal Patch Panel Copper Ports

- Individual ports on the patch panel shall be colour coded as detailed below.

Type	Colour
Outlets	BLACK ON WHITE

- The patch panels individual label shall be colour coded as detailed below.

Product	Colour
Horizontal Patch Panel	BLACK ON WHITE

c.3 Label Colour – Patch Panel Fibre Ports

- Individual ports on the patch panel shall be colour coded as detailed below.

Type	Colour
Singlemode Campus	WHITE ON BLUE
Singlemode Building	BLUE ON WHITE
Multimode Campus	WHITE ON BLACK
Multimode Building	WHITE ON RED

- The patch panels individual label shall be colour coded as detailed below.

Type	Colour
Patch Panel	BLACK ON WHITE

c.4 Labelling Scheme – Outlets

- Each individual port

AA - Telecom Room (AA to ZZ)
 BBB - Outlet number (001 to 999)

- The below example for a quad outlet would be:

Telecom Room - HV
 Ports - 025 to 028

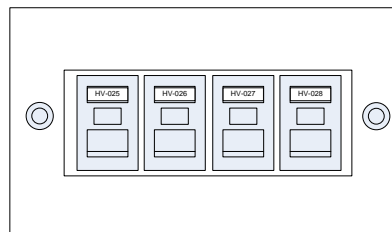

c.5 Labelling Scheme – Minipod or Floor Box

- Each individual port

AA - Telecom Room (AA to ZZ)
 BBB - Outlet number (001 to 999)

NOTE – the ports shall be labelled left to right and top to bottom with the top being the cable entry point.

- The below example for a 6 way Minipod would be:

Telecom Room	-	HV
Ports	-	025 to 030

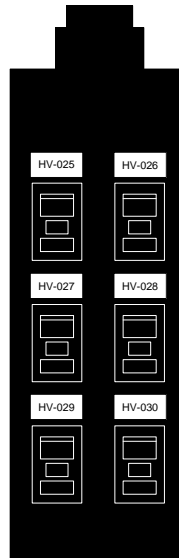

c.6 Labelling Scheme – Horizontal Patch Panel

- A patch panel label

AA	-	Telecom Room (AA to ZZ)
BB	-	Patch Panel Number (01 to 99)
CC	-	Floor (01 to 99)

- Minipod, floor box or transition point

AAA	-	Minipod or Floor Box Number (001 to 999)
BB	-	Outlet number (01 to 99)

- Single and double gang outlets.

AAA	-	Outlet number (001 to 999)
-----	---	----------------------------

Example 1 The below example for horizontal patch panel number 02 located in telecom room HV supplying the first four off 6 port Minipods located on the 3rd floor would be:

Telecom Room	-	HV
Patch Panel	-	02
Floor	-	03
Minipod number	-	001 to 004
Ports	-	001 to 006 (on Minipods 01 to 04)

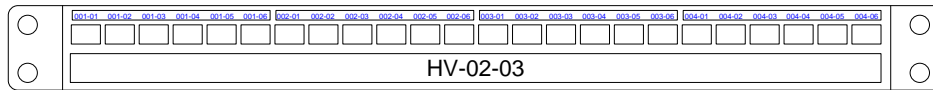

Example 2 The below example for horizontal patch panel number 11 located in telecom room HV supplying the first 24 off outlets located on the 5th floor would be:

Telecom Room - HV
Patch Panel - 11
Ports - 001 to 024

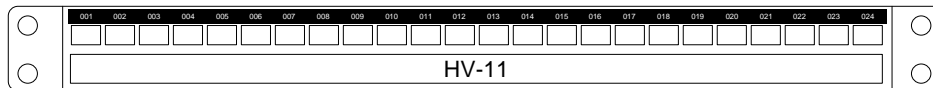

c.7 Labelling Scheme – Backbone Fibre

1. A patch panel label for each individual fibre cable

A - Alpha character 'B' to signify a building
 BBB - Source building number (001 to 999)
 CC - Source hub room (AA to ZZ)
 F - Alpha character 'F' to signify a patch panel
 GG - Source patch panel number (01 to 99)
 HH - Source start fibre port number (01 to 99)
 II - Source end fibre port number (01 to 99)
 J - Alpha character 'B' to signify a building
 KKK - Destination building number (001 to 999)
 LL - Destination hub room (AA to ZZ)
 M - Alpha character 'F' to signify a patch panel
 NN - Destination patch panel number (01 to 99)
 OO - Destination start fibre port number (01 to 99)
 PP - Destination end fibre port number (01 to 99)

2. Each individual port

AA - Outlet number (01 to 99)

The below example for a fibre singlemode campus backbone patch panel would be:

Building - B36
 Telecom Room - AK
 Patch Panel - 01
 Start port - 01
 End port - 08

Are connected to:

Building	-	B20
Telecom Room	-	BS
Patch Panel	-	01
Start port	-	09
End port	-	16

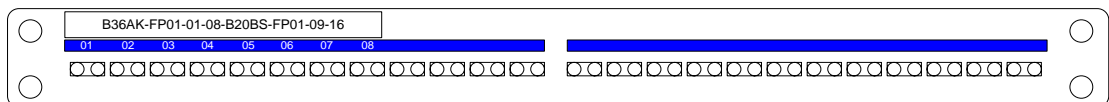

The above example shown details a patch panel that has one off 16 core (8 duplex channel).

c.8 Labelling Scheme – Fibre Patch Panel

1. A fibre patch panel label with white on black

AA	-	Alpha characters 'FP' to signify a Fibre Panel
BB	-	Patch panel number (01 to 99)

The below example for a fibre patch panel would be:

Fibre panel	-	FP
Fibre panel number	-	01



c.9 Labelling Scheme – Cabinet

1. Two off cabinet labels, one on the front of the cabinet and one on the rear. Colour shall be White on Red

AA	-	Telecom Room Floor (Basement – B, First – 01, etc)
BB	-	Telecom Room (01 to 99)
CDD	-	Row (A to Z) and Cabinet (01 to 99)
E	-	Front or Rear of Cabinet (F or R)

The below example for a cabinet would be:

Telecom room floor	-	01
Telecom Room	-	HZ
Row	-	A
Cabinet	-	03
Front / Rear	-	F/R (as appropriate)

01-HZ-A03-F

c.10 Labelling Scheme – Commando Socket

1. A commando socket label with White on Red

AA	-	Telecom Room Floor (Basement – B, First – 01, etc)
BB	-	Telecom Room (01 to 99)
CDD	-	Row (A to Z) and Cabinet (01 to 99)
CS	-	‘Command Socket’
E	-	Command Socket Identifier (A or B)

The below example for a commando socket would be:

Telecom room floor	-	01
Telecom room	-	HZ
Row	-	A
Cabinet	-	03
Command socket	-	CS
Command socket identifier	-	A

01-HZ-A03-CSA

c.11 Labelling Scheme – PDU

2. A PDU label with White on Red

AA	-	Telecom Room Floor (Basement – B, First – 01, etc)
----	---	--

BB	-	Telecom Room (01 to 99)
CDD	-	Row (A to Z) and Cabinet (01 to 99)
PDU	-	'PDU'
E	-	PDU Identifier (A or B)

The below example for a PDU would be:

Telecom room floor	-	01
Telecom room	-	HZ
Row	-	A
Cabinet	-	03
PDU	-	PDU
PDU identifier	-	A

01-HZ-A03-PDUA

c.12 Labelling Scheme – Horizontal Cable

1. Brady wrap around label at both ends of the horizontal cable. The labelling scheme shall follow the same scheme as Minipods, floor boxes and outlets.

c.13 Labelling Scheme – Copper Patch Leads

1. Brady wrap around label at both ends of the patch lead.

AA	-	Patch Panel Number (01 to 99)
BB	-	Port Number (01 to 99)

c.14 Labelling Scheme – Backbone Fibre Cable

1. A cable label for each individual fibre cable at both ends and each riser floor

A	-	Alpha character 'B' to signify a building
BBB	-	Source building number (001 to 999)
CC	-	Source hub room (AA to ZZ)
F	-	Alpha character 'F' to signify a patch panel
GG	-	Source patch panel number (01 to 99)
HH	-	Source start fibre port number (01 to 99)

II	-	Source end fibre port number (01 to 99)
J	-	Alpha character 'B' to signify a building
KKK	-	Destination building number (001 to 999)
LL	-	Destination hub room (AA to ZZ)
M	-	Alpha character 'F' to signify a patch panel
NN	-	Destination patch panel number (01 to 99)
OO	-	Destination start fibre port number (01 to 99)
PP	-	Destination end fibre port number (01 to 99)

The below example for a fibre singlemode campus backbone patch panel would be:

Building	-	B36
Telecom Room	-	AK
Patch Panel	-	01
Start port	-	01
End port	-	08

Are connected to:

Building	-	B20
Telecom Room	-	BS
Patch Panel	-	01
Start port	-	09
End port	-	16

B36AK-FP01-01-08-B20BS-FP01-09-16

c.15 Labelling Scheme – Fibre Patch Leads

1. Brady wrap around label at the patch panel end of the fibre patch lead.

AA	-	Cabinet U Number (01 to 99)
B	-	Switch Stack (1 to 9)
C	-	Switch Number (1 to 9)
DD	-	Port Number (01 to 99)

2. Brady wrap around label at the switch end of the fibre patch lead.

AA	-	Cabinet U Number (01 to 99)
BB	-	Patch Panel Number (01 to 99)
CC	-	Port Number (01 to 99)

c.16 Labelling Scheme – Mains Leads

1. Brady wrap around label at both ends of the mains lead.

AA	-	Cabinet U Number (01 to 99)
B	-	Switch Stack (1 to 9)
C	-	Switch Number (1 to 9)
D	-	Feed Number

c.17 Labelling Scheme – Earth Cables for Cabinets

1. Two off earth cable labels, one at each end of the cable. Colour shall be black on yellow

AA	-	Telecom Room Floor (Basement – B, First – 01, etc)
BB	-	Telecom Room (AA to ZZ)
CDD	-	Row (A to Z) and Cabinet (01 to 99)

The below example for a cabinet earth bonding cable would be:

Telecom room floor	-	01
Telecom Room	-	HZ
Row	-	A
Cabinet	-	03



c.18 Labelling Scheme – Earth Cables for Suspended Floor

1. Two off earth cable labels, one at each end of the cable. Colour shall be black on yellow

AA	-	Telecom Room Floor (Basement – B, First – 01, etc)
BB	-	Telecom Room (AA to ZZ)
Floor	-	'Floor'

The below example for a suspended floor earth bonding cable would be:

Telecom room floor	-	01
Telecom Room	-	HZ
Floor	-	Floor

01-HZ-Floor

c.19 Labelling Scheme – EVC Telco Cable

1. Two off EVC cable labels, one at each end of the cable. Colour shall be Critchley black on white

A	-	Alpha character 'B' to signify source building
BBB	-	Source building number (001 to 999)
C	-	Alpha character 'B' to signify destination building
DDD	-	Destination building number (001 to 999)
EVC	-	'EVC'

The below example for an EVC cable from B057 to B100 would be:

Source Building	-	B057
Destination Building	-	B100
EVC	-	EVC

B057-B100-EVC

c.20 Labelling Scheme – FireTuf Cables

1. Two off FireTuf cable labels, one at each end of the cable. Colour shall be black on white

AAA	-	Outlet number (001 to 999)
-----	---	----------------------------

The below example for a FireTuf cable would be:

Outlet 454	-	454
------------	---	-----

454

c.21 Labelling Scheme – EVC Distribution Frame, Rack or Wall Box

1. One off EVC DP labels. Colour shall be engraved traffolyte black on white

A	-	Alpha character 'B' to signify source building
BBB	-	Source building number (001 to 999)
C	-	Alpha character 'B' to signify destination building
DDD	-	Destination building number (001 to 999)
EVC	-	'EVC'

The below example for an EVC DP from B057 to B100 would be:

Source Building	-	B057
Destination Building	-	B100
EVC	-	EVC

B057-B100-EVC

c.22 Labelling Scheme – Blown Fibre Overview

The diagram below shows an end to end solution diagram of blown fibre tubing and details the different labelling components required.

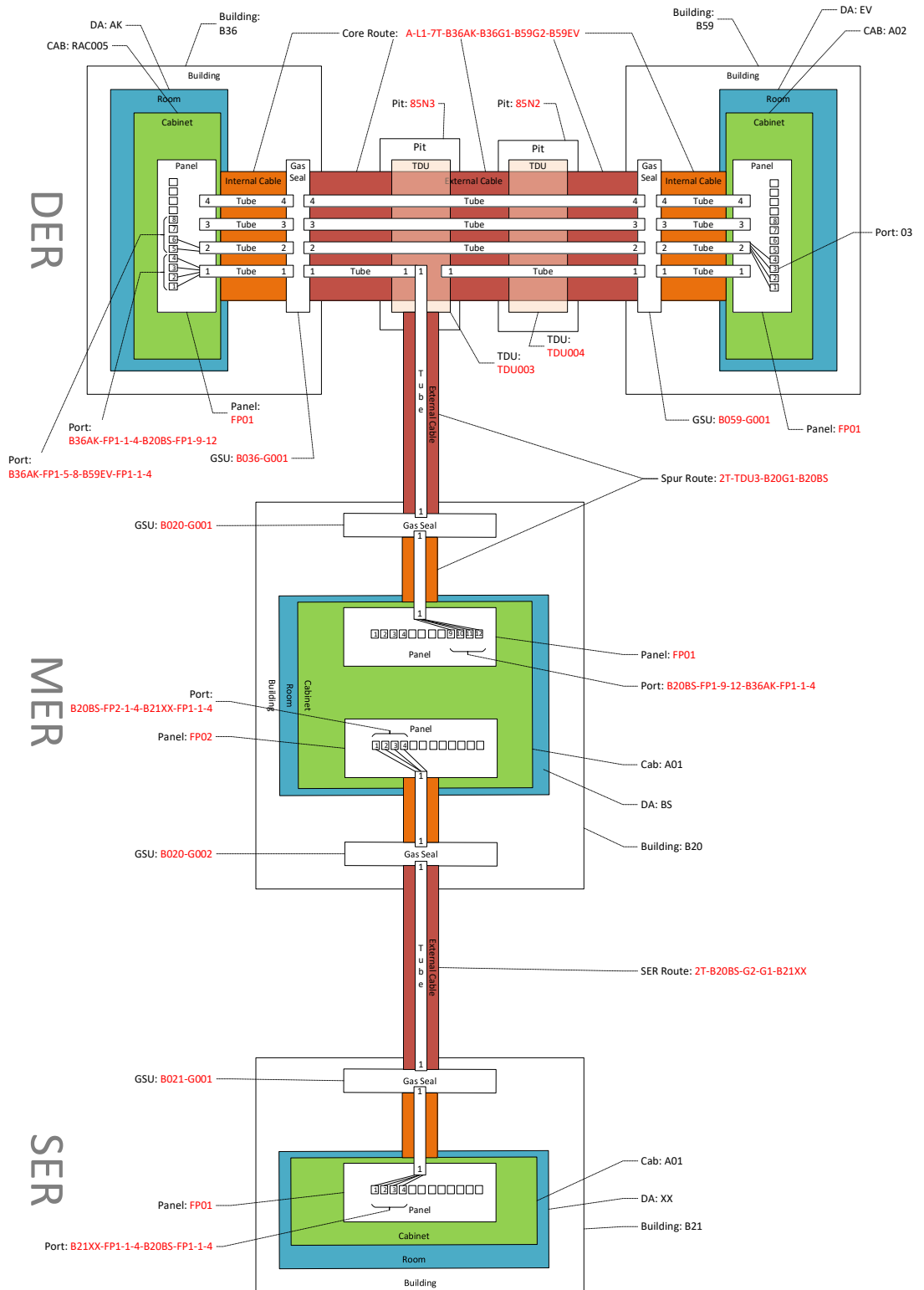

The below table details the component identifier summary.

Identifier	Assigned by	Uniqueness	Identifier Example
------------	-------------	------------	--------------------

Organisation	UoS	UoS	
Site	iSolutions	Organisation	HFC
Pit	Estates	Organisation	85N6
Gas Seal	Electranet	Building	G1
TDU	Electranet	Organisation	TDU001
Building	Plannon	Organisation	B36
Building Entry Point	Electranet	Building	BEP1
Room	Plannon	Building	2059
DA	iSolutions	Organisation	AK
Cabinet	iSolutions	DA	RAC005
Panel	Electranet	DA	FP1
Port	-	Panel	B36AK-FP1-1-4-B20BS-FP1-9-12
Route	Electranet	Site	A
Leg	Electranet	Route	1
Core Route	Electranet	Organisation	A-L1-7T-B36AK-B36G1-B59G2-B59EV
Spur Route	Electranet	Organisation	2T-TDU3-B20G1-B20BS
MER to SER Route	Electranet	Organisation	2T-B44CB-B44AI
Tube	-	Cable Segment	<core or spur route label>-2
Core	-	Cable Segment	<colour coded>
Segment	caplum	Caplum	n/a - internal Caplum construct

C.14a Labelling Scheme – Blown Fibre Gas Seal

A label on every Gas Seal in each building. Label numbers are unique per building.

1. Traffolyte engraved label on each Gas Seal with White on Red.

A	-	Alpha character 'B' to signify a building
BBB	-	Building number (001 to 999)
C	-	Alpha character 'G' to signify a Gas Seal Unit
DDD	-	Gas Seal number (001 to 999)

The below example for a Gas Seal Unit would be:

Building	-	B
Building Number	-	036
Gas Seal	-	G
Gas Seal Number	-	001



B036-G001

C.14b Labelling Scheme – Blown Fibre TDU

A label on every TDU. Label numbers are unique per site.

Engraved label on each TDU with Black on White.

AAA	-	Alpha characters 'TDU' to signify a TDU
BBB	-	TDU number (001 to 999)

The below example for a TDU would be:

TDU	-	TDU
TDU Number	-	075



TDU075

C.14c Labelling Scheme – Core Blown Fibre Duct Route

A label displayed at key points on each main fibre-optic cable route e.g. pits, building entry points, terminations etc.

1. Critchely label on each blown fibre tube unit.

A	-	Duct route that the cable takes between site cores (A to Z)
B	-	Alpha character 'L' to signify a Leg Number
C	-	Leg number (0 to 9)
DD	-	Number of tubes in the blown fibre unit (00 to 99)
E	-	Alpha character 'T' to signify a blown fibre Tube unit
F	-	Alpha character 'B' to signify a building
GGG	-	Source building number (001 to 999)

HH	-	Source hub room (AA to ZZ)
I	-	Alpha character 'B' to signify a building
JJJ	-	Source building number (001 to 999)
K	-	Alpha character 'G' to signify Gas Seal unit
LLL	-	Source gas seal number (000 to 999)
M	-	Alpha character 'B' to signify a building
NNN	-	Destination building number (001 to 999)
OO	-	Destination gas seal number (00 to 99)
P	-	Alpha character 'B' to signify a building
QQQ	-	Destination building number (001 to 999)
RR	-	Destination hub room (AA to ZZ)

The below example for a core route blown fibre tube unit would be:

Duct route	-	A
Leg	-	L
Leg number	-	01
Number of tubes in the unit	-	07
Tube	-	T
Building	-	B
Source building number	-	36
Source hub room number	-	AK
Building	-	B
Source building number	-	36
Gas seal	-	G
Source gas seal number	-	001
Building	-	B
Destination building number	-	59
Gas seal	-	G
Source gas seal number	-	002
Building	-	B
Destination building number	-	59
Destination hub room number	-	EV

A-L1-7T-B36AK-B36G1-B59G2-B59EV

C.14d Labelling Scheme – Spur Blown Fibre Duct Route

A label displayed at key points on each spur fibre-optic cable route e.g. pits, building entry points, terminations etc.

1. Critchely label on each blown fibre tube unit.

AA	-	Number of tubes in the blown fibre unit (00 to 99)
B	-	Alpha character 'T' to signify a blown fibre Tube unit
CCC	-	Alpha characters 'TDU' to signify a TDU
DDD	-	TDU number (001 to 999)
E	-	Alpha character 'B' to signify a building
FFF	-	Source building number (001 to 999)
GG	-	Source hub room (AA to ZZ)
H	-	Alpha character 'B' to signify a building
III	-	Source building number (001 to 999)
J	-	Alpha character 'G' to signify Gas Seal unit
KKK	-	Source gas seal number (000 to 999)

The below example for a core route blown fibre tube unit would be:

Number of tubes in the unit	-	02
TDU	-	TDU
TDU Number	-	003
Tube	-	T
Building	-	B
Building number	-	20
Hub room number	-	BS
Building	-	B
Building number	-	20
Gas seal	-	G
Source gas seal number	-	001

2T-TDU003-B20BS-B20G001

C.14e Labelling Scheme – MER to SER Duct Route

A label displayed at key points on each spur fibre-optic cable route e.g. pits, building entry points, terminations etc.

1. Critchely label on each blown fibre tube unit.

AA	-	Number of tubes in the blown fibre unit (00 to 99)
B	-	Alpha character 'T' to signify a blown fibre Tube unit
C	-	Alpha character 'B' to signify a building
DDD	-	Source building number (001 to 999)
EE	-	Source hub room (AA to ZZ)
F	-	Alpha character 'B' to signify a building
GGG	-	Destination building number (001 to 999)
HH	-	Destination hub room (AA to ZZ)

The below example for a core route blown fibre tube unit would be:

Number of tubes in the unit	-	02
Tube	-	T
Building	-	B
Building number	-	44
Hub room number	-	CB
Building	-	B
Building number	-	44
Hub room number	-	AI

2T-B44CB-B44AI

Appendix D Main Contractor Hub Room Sign Off checklist

D.1 Check List

- Each line item MUST be signed off as YES or NO
- The document MUST be signed off as completed – Company Name, Name of Person, Signature and Date

Building: Hub room number:	YES/NO
Item	
Physical	
Size of room - 1 x Rack = 2.4 x 3.4 (2 x rack = 3.2 x 3.4)(4 x rack 3.4 x 4.7) 5 x Rack with UPS (3.4 x 5.9)	
Door signage in place	
iSolutions Hub room door lock fitted Mult T Lock M50 University issue	
Door handle furniture in place	
Door decoration completed	
Glass toughened vision panel in place	
Ceiling decorated and free of snags	
Walls decorated and free of snags	
Is the floor finish anti-static	
Floor finished and free of snags	
If windows are present have they been fitted with film	
If windows are present have they been fitted with security measures	
Has all fire stopping been fitted	
Is there clear, safe access to the hub room	
Electrical	
Lighting and power controls present	
Lighting providing an even coverage of the room	
All electrical containment in place	
2 x 32 amp commando sockets mounted above each active rack	
2 x 12 way Raritan PDU's mounted in each active rack, zero U style	
Each PDU supply must be on a separate breaker from the distribution board	
Smoke detector fitted	
All components of the Racks have been physically earth bonded	
Double UTP outlet fitted for a telephone	
All data containment complete	
25% additional capacity provided for additional channels	

Audibility of the nearest fire alarm sounder checked	
UPS installed and commissioned by Vertiv and connected to Life Net, output wired to frame PDU's.	
Raritan PDU's connected to network and accessible on network for temperature reporting.	
Camera connected to network and streaming images.	
IT	
Ortronics Mighty Mo 20 Frames installed with vertical cable managers	
Test results supplied for all horizontal cabling	
As built drawings supplied	
Data fibre schematic drawings supplied	
Patching schedule supplied	
Door and sides fitted	
Racks are bayed and labelled	
Patch panels labelled	
Fibre and copper cables labelled	
All fibre and copper patch cables are labelled	
Mains patch cables labelled	
Mechanical	
10kW cooling installed and working for MER and 5Kw for SER	
Failover test witnessed for transfer from free cooling to DX cooling and reverse back to free cooling.	
No wet services supplies or drainage to pass through or over hub room	
Cooling not fitted over the rack	
Cooling fed electrically off own electrical isolator	
24 hour cooling provided 24 x 365 days of the year	
Temperature of room between 21 - 23 degrees	
Cooling controller in place	
Earthing	
Hub room earth bar installed	
Frame earth bars installed	
Frame earth bars bonded to the telecom room earth bar	
Frame doors, side panels, plinths and top cover bonded to the cabinet earth bar	
Patch panels bonded to the frame earth bar	
PDU's bonded to the frame earth bar	

Company:

Name:

Signature:

Date:

Appendix E WLAN Predictive Modelling Parameters

WLAN predictive modelling shall be in accordance with the latest version of the below iSolutions specifications. The latest version shall be obtained from iSolutions before design work is undertaken.

- WLAN standards performance specification detail
- Wireless LAN Standards
- Wireless LAN standards Checklist

Appendix F - Call Point Specification

Viking E-1600-45A-EWP. University Framework supplier for EVC is Daisy Communications.



Appendix H DCIM Configuration

H.1 MER - Requirements and commissioning of UPS Life Net for Vertiv remote monitoring

Vertiv UPSs must be setup to connect to LIFE.

Details of the service are available on the Vertiv site

<https://www.vertivco.com/en-us/services-catalog/maintenance-services/remote-services/life-services/>

Details on configuring the LIFE services

<https://www.vertivco.com/globalassets/shared/Liebert-IntelliSlot-Unity-Card-UM-EN-NA-SL-52645.pdf>

Requirements:

- Request a static IP (Including stack name, Card MAC Address)
- Vertiv must configure the UPS LIFE service as part of the UPS commissioning process.
- Email soc@soton.ac.uk the MAC addresses and device details (Make, Model and location)

H.2 Supply and commission 1U Raritan PDUs

It is expected that all PDU installations for supplying power to the racks is solely supplied by Raritan, where a 0U PDU is insufficient a 1U Raritan PDU may be added to support POE injectors.

List of expectable parts;

- Switchable PDU – Part Number: PX3-5190CR-Q1

<https://www.raritan.com/product-selector/pdu-detail/px3-5190cr-q1>

Requirements

- 2 x Static IP assigned via DHCP for each PDU(See “Request a Static IP address“ Including stack name, PDU MAC Address(es) and location in rack
- 1 x C19 to C20 power lead.
- Patch each PDU with 1 or 2 x Cat 6 cable to switch stacks (See diagram below)
- 6mm Earth cable and correctly sized Insulated Crimp Ring Terminals.
- All empty outlets must be switched off
- Email soc@soton.ac.uk the MAC addresses and device details (Make, Model and location)

H.3 Supply and commission 0U Raritan PDUs

It is expected that all PDU installations for supplying power to the racks is solely supplied by Raritan

List of expectable parts;

- Switchable PDU – Part Number: PX3-5842V
<https://www.raritan.com/product-selector/pdu-detail/px3-5842v>
- Single Temp and Hum Sensor – Part Number: DPX3-T1H1
- Pair Temp and Hum Sensors – Part Number: DPX3-T2H2-KIT
- Leak Sensor – Part Number: DPX-WSC-35-KIT
- Sensor Hub – Part Number: DPX3-ENVHUB4
- PIR Sensor – Part Number: DX-PIR
<https://www.raritan.com/products/power/accessories/environmental-sensors>

Sensor installation guide https://d3b2us605ptvk2.cloudfront.net/download/px3/version-3.4.0/SensorGuide_1B_3.4.0.pdf

Requirements

- 2 x Static IP assigned via DHCP for each PDU(See “Request a Static IP address“ Including stack name, PDU MAC Address(es) and location in rack
- 2 x 32Amp Command sockets per powered rack
- 1 x Pair Temp and Hum Sensor per rack (Required for all non MERs)
- Patch each PDU with 1 or 2 x Cat 6 cable to switch stacks (See diagram below)
- 6mm Earth cable and correctly sized Insulated Crimp Ring Terminals.
- PDU orientation – outlet 30 at top of rack
- All empty outlets must be switched off
- Email soc@soton.ac.uk the MAC addresses and device details (Make, Model and location)

Multiple switch deployment

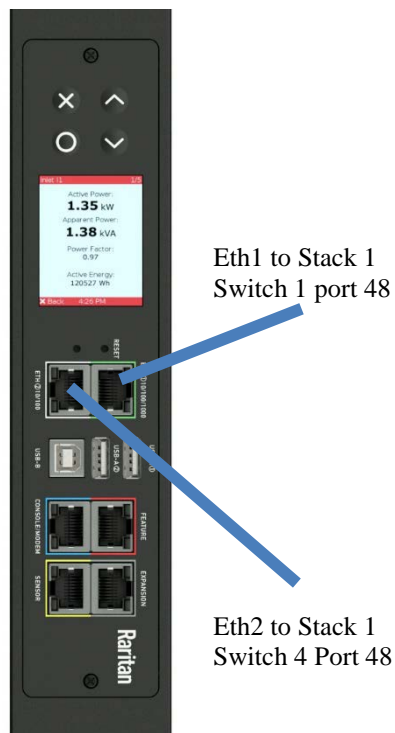

Single switch rack

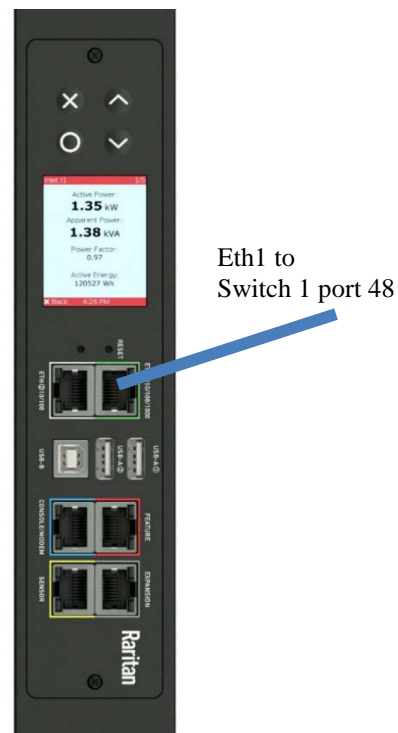

As part of the technical submission please provide a diagram of the equipment to be fitted and the layout of all parts for technical approval.

H.4 MER - Requirements and commissioning of Environmental Monitoring

It is expected that all MERs DCIM installations for monitoring the environment and its security is solely supplied by APC

List of expectable parts;

- Netbotz appliance - Part number: NBRK0570

<https://www.apc.com/shop/uk/en/products/NetBotz-Rack-Monitor-570/P-NBRK0570>

- Door contact- Part number: NBES0313

<https://www.apc.com/shop/uk/en/products/NetBotz-Door-Switch-Sensor-for-an-APC-Rack-62-in-used-with-NetBotz-Wireless-Sensor-Pod-180-/P-NBES0313?isCurrentSite=true>

- Leak rope 20ft - Part number: NBES0308

<https://www.apc.com/shop/uk/en/products/NetBotz-Leak-Rope-Sensor-20-ft-/P-NBES0308?isCurrentSite=true>

- Leak rope extension cable 20ft - Part number: NBES0309

<https://www.apc.com/shop/uk/en/products/NetBotz-Leak-Rope-Extension-20-ft-/P-NBES0309?isCurrentSite=true>

- Camera - Part number: NBPD0160A

<https://www.apc.com/shop/uk/en/products/NetBotz-Camera-Pod-160/P-NBPD0160A?isCurrentSite=true>

- Temperature sensors - Part number: AP9335TH

<https://www.apc.com/shop/uk/en/products/APC-Temperature-Humidity-Sensor/P-AP9335TH?isCurrentSite=true>

Requirements

- Static IP assigned via DHCP (See “Request a Static IP address“ Including stack name, Netbotz MAC Address(es) and location
- Cat 6 cable for connecting PDU to switch stack
- CCTV signage on door
- Lockable Raritan power leads of the correct length IEC C13/C14 (available lengths 0.5 – 5M)
- Monitoring Humidity and Temperature at front of active racks.
- Door switch and camera(s)
- Email soc@soton.ac.uk the MAC addresses and device details (Make, Model and location)

As part of the technical submission please provide a diagram of the equipment to be fitted and the layout of all parts for technical approval.

H.5 IEC Leads

List of acceptable parts;

https://www.raritan.com/assets/re/resources/data_sheets/RE-ds-SecureLock.pdf

Colour requirements and layout – PDU1 **Red** and PDU2 - Blue

Example

PDU1 - IEC C13/C14 – Colour **Red** – Example use, Netbotz, VICOM

PDU1 - IEC C19/C20 – Colour **Red** – Example use, VICOM storage, 1U Raritan PDUs

PDU2 - IEC C19/C20 – Colour **Blue** – Example use, VICOM storage, 1U Raritan PDUs

PDU1 - IEC C14/C15 – Colour **Red** – Example use, Cisco Switches

PDU2 - IEC C14/C15 – Colour **Blue** – Example use, Cisco Switches

AVAILABLE SECURELOCK POWER CABLES		
IEC C13/C14 SecureLock Cables		Pack of 6 SecureLock locking cables, 0.5 Meter up to 3.0 Meter, 16AWG, 1 x IEC C-14, 1 x IEC C-13
Black Cables	Red Cables	Blue Cables
SLC14C13-0.5M-6PK	SLC14C13-0.5MK1-6PK	SLC14C13-0.5MK2-6PK
SLC14C13-1.0M-6PK	SLC14C13-1.0MK1-6PK	SLC14C13-1.0MK2-6PK
SLC14C13-1.5M-6PK	SLC14C13-1.5MK1-6PK	SLC14C13-1.5MK2-6PK
SLC14C13-2.0M-6PK	SLC14C13-2.0MK1-6PK	SLC14C13-2.0MK2-6PK
SLC14C13-2.5M-6PK	SLC14C13-2.5MK1-6PK	SLC14C13-2.5MK2-6PK
SLC14C13-3.0M-6PK	SLC14C13-3.0MK1-6PK	SLC14C13-3.0MK2-6PK
IEC C19/C20 SecureLock Cables		Pack of 6 SecureLock locking cables, 0.5 Meter up to 3.0 Meter, 16AWG, 1 x IEC C-19, 1 x IEC C-20
Black Cables	Red Cables	Blue Cables
SLC20C19-0.5M-6PK	SLC20C19-0.5MK1-6PK	SLC20C19-0.5MK2-6PK
SLC20C19-1.0M-6PK	SLC20C19-1.0MK1-6PK	SLC20C19-1.0MK2-6PK
SLC20C19-1.5M-6PK	SLC20C19-1.5MK1-6PK	SLC20C19-1.5MK2-6PK
SLC20C19-2.0M-6PK	SLC20C19-2.0MK1-6PK	SLC20C19-2.0MK2-6PK
SLC20C19-2.5M-6PK	SLC20C19-2.5MK1-6PK	SLC20C19-2.5MK2-6PK
SLC20C19-3.0M-6PK	SLC20C19-3.0MK1-6PK	SLC20C19-3.0MK2-6PK
IEC C14/C15 SecureLock Cables		Pack of 6 SecureLock locking cables, 0.5 Meter up to 3.0 Meter, 16AWG, 1 x IEC C-14, 1 x IEC C-15
Black Cables	Red Cables	Blue Cables
SLC14C15-0.5M-6PK	SLC14C15-0.5MK1-6PK	SLC14C15-0.5MK2-6PK
SLC14C15-1.0M-6PK	SLC14C15-1.0MK1-6PK	SLC14C15-1.0MK2-6PK
SLC14C15-1.5M-6PK	SLC14C15-1.5MK1-6PK	SLC14C15-1.5MK2-6PK
SLC14C15-2.0M-6PK	SLC14C15-2.0MK1-6PK	SLC14C15-2.0MK2-6PK
SLC14C15-2.5M-6PK	SLC14C15-2.5MK1-6PK	SLC14C15-2.5MK2-6PK
SLC14C15-3.0M-6PK	SLC14C15-3.0MK1-6PK	SLC14C15-3.0MK2-6PK
SLC14C15-3.5M-6PK	SLC14C15-3.5MK1-6PK	SLC14C15-3.5MK2-6PK
SLC14C15-5.0M-6PK	SLC14C15-5.0MK1-6PK	SLC14C15-5.0MK2-6PK

The correct length cable must be installed to connect an appliance to the PDUs.

IEC leads shall not be bundled together.

Velcro may be used to retain an IEC Lead.

IECs connected to Cisco Switches must be looped as shown below.

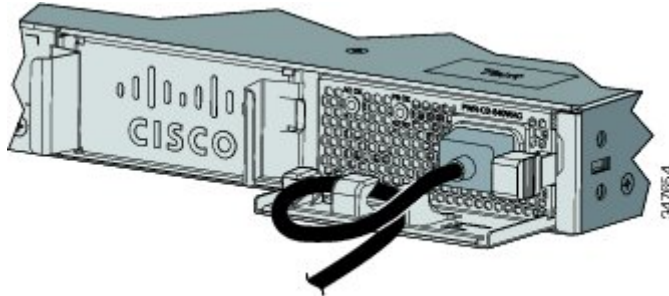

Active Switch Cabinet IEC layout

Type	Outlet	PDU1	PDU2
IEC320 C13	30	Reserved for EMS	Not used
IEC320 C13	29	Not used	Not used
IEC320 C13	28	Stack 1 Switch 1	
IEC320 C13	27		Stack 2 Switch 2
IEC320 C19	26	Supply to 1U PDU	
IEC320 C13	25	Stack 1 Switch 3	
IEC320 C13	24		Stack 1 Switch 4
IEC320 C13	23	Stack 1 Switch 5	
IEC320 C13	22		Stack 1 Switch 6
IEC320 C19	21	Supply to 1U PDU	
IEC320 C13	20	Stack 1 Switch 7	
IEC320 C13	19		Stack 1 Switch 8
IEC320 C13	18	Stack 1 Switch 9	
IEC320 C13	17		
IEC320 C19	16	Supply to 1U PDU	
IEC320 C13	15		
IEC320 C13	14	Stack 2 Switch 1	
IEC320 C13	13		Stack 2 Switch 2
IEC320 C13	12	Stack 2 Switch 3	
IEC320 C19	11	Supply to 1U PDU	
IEC320 C13	10		Stack 2 Switch 4
IEC320 C13	9	Stack 2 Switch 5	
IEC320 C13	8		Stack 2 Switch 6
IEC320 C13	7	Stack 2 Switch 7	
IEC320 C19	6	Supply to 1U PDU	
IEC320 C13	5		Stack 2 Switch 8
IEC320 C13	4	Stack 2 Switch 9	
IEC320 C13	3		
IEC320 C13	2		
IEC320 C19	1	Supply to 1U PDU	

H.6 Requesting a Static IP address

This should be done using the form located within the main document page.

Appendix I – Testing for Single Mode Fibre Links

I.1 Test Reference Cord (TRC) Verification –For LSPM

1. Check that the tester is in calibration (proof of independently calibration by Contractor may be requested). If out of calibration do not use.
2. Ensure that the tester has more than 25% of its battery life left, if less than 25% the unit must be recharged
3. Select two leads to be accessed for use as TRCs. One lead will be known as lead A and the second as lead B. The leads must be:
 - 2m in length
 - One end to be the same connector type as the tester and the other the same type as the link to be tested
 - Cable must be the same type as the link under test i.e. OS2 etc
4. Check the condition of the leads by means of visual inspection using a microscope or fibre viewer
5. Clean both ends of the leads
6. Plug lead A into the light source meter connector labelled ‘Output’
7. Plug lead A into the power meter connector labelled ‘Input’

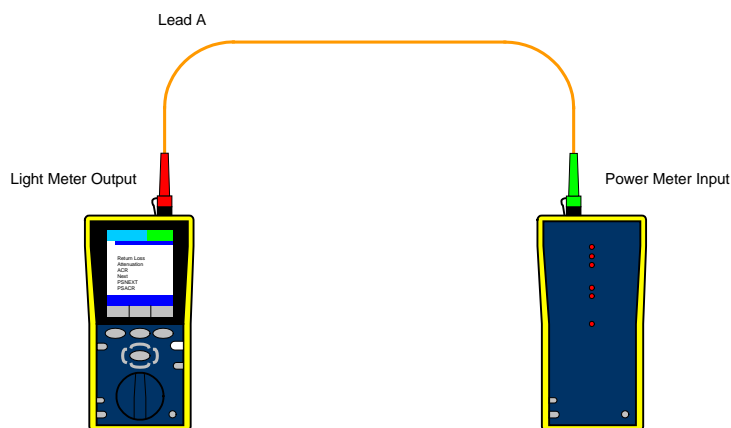

8. Record the power meter reading
9. Remove lead A from the power meter
10. Insert lead B into the power meter connector labelled ‘Input’
11. Connect lead A to lead B with a single mode coupling adapter

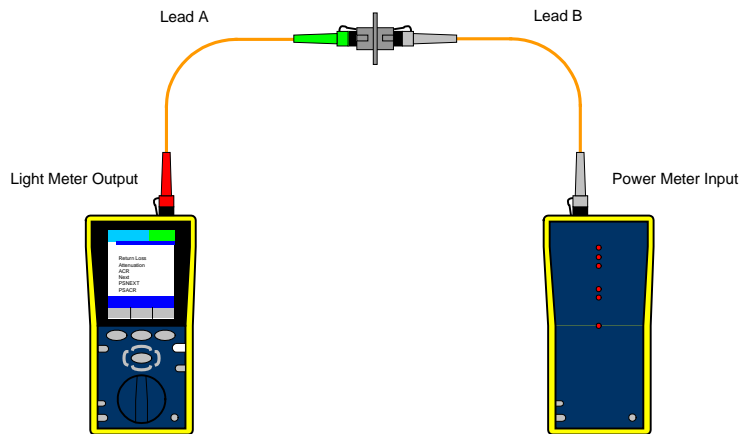

12. Record the result with the LSPM set in relative mode

13. Flip lead A so that the connector coupled with lead B now connects to the light meter connector labelled 'Output' and the connector coupled with the light meter connector labelled 'Output' connects to lead B

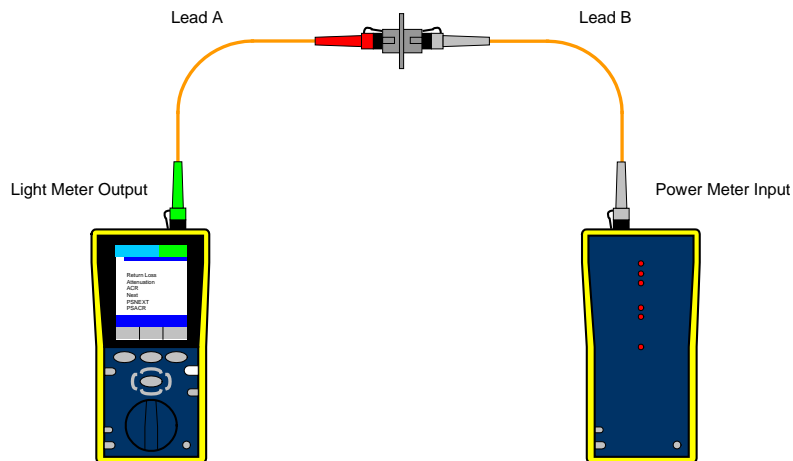

14. Record the result with the LSPM set in relative mode

15. If the results from steps 10 and 12 both fall within 0.2dB for LC, SC and ST connectors lead A can be used as a TRC.

I.2 Reference Setting -1 Jumper Method

For testers that have the same connector as the test link or have interchangeable connectors the 1 jumper method must be used.

1. Check that the tester is in calibration (proof of independently calibration by Contractor may be requested). If out of calibration do not use.
2. Ensure that the tester has more than 25% of its battery life left, if less than 25% the unit must be recharged
3. Select the two reference leads to be used for testing. One lead will be known as lead A and the second as lead B. The leads must be:
 - 1 to 5m in length

- Cable must be the same type as the link under test i.e. OS2 etc
 - The leads must be known referenced leads and must be referenced at the start of each day
4. Check the condition of the leads by means of visual inspection using a microscope or fibre viewer
 5. Clean both ends of the leads.
 6. Plug lead A into the light source meter connector labelled 'Output'
 7. Plug lead A into the power meter connector labelled 'Input'

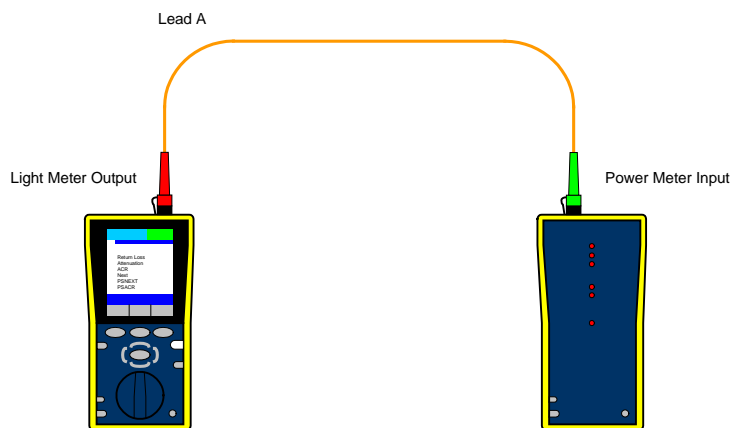

8. Ensure that the result is less than -80.2dB at 1310 and 1550nm
9. Reference the power meter reading

I.3 Reference Setting -3 Jumper Method

For testers that have a **different** connector as the test link and do not have interchangeable connectors reference the 3 jumper method **shall** be used.

1. Check that the tester is in calibration (proof of independently calibration by Contractor may be requested). If out of calibration do not use.
2. Ensure that the tester has more than 25% of its battery life left, if less than 25% the unit must be recharged
3. Select the two reference leads to be used for testing. One lead will be known as lead A and the second as lead B. The leads must be:
 - 1 to 5m in length
 - Cable must be the same type as the link under test i.e. OS1, OS2 etc
 - The leads must be known referenced leads and must be referenced at the start of each day
4. Select the field calibration cord to be used for testing.
 - ≤ 2 m in length
 - Cable must be the same type as the link under test i.e. OS2 etc
 - The lead must be a known field calibration lead and must be referenced at the start of each day
5. 4. Check the condition of the leads by means of visual inspection using a microscope or fibre viewer
6. Clean both ends of the leads
7. Plug lead A into the light source meter connector labelled 'Output'
8. Plug lead B into the power meter connector labelled 'Input'
9. Connect one end of the field calibration lead to lead A with a single mode adapter
10. Connect the other end of the field calibration lead to lead B with a single mode adapter

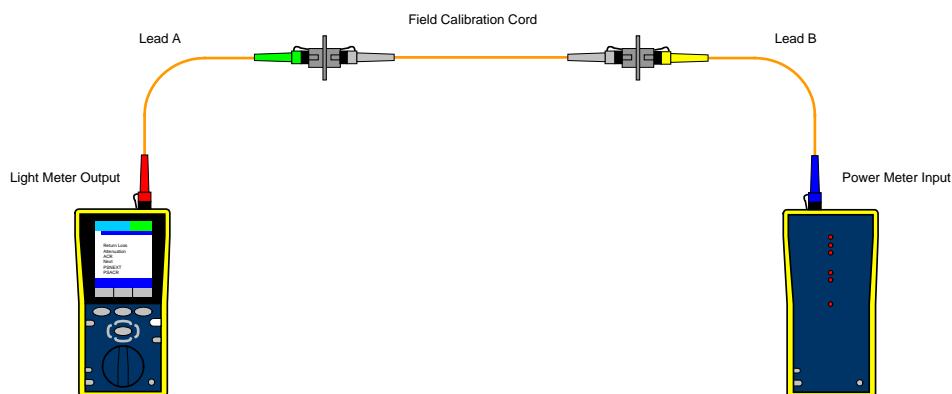

11. The loss budget must be better than -0.2dB at 1330 and 1550nm

- Reference the power meter reading

I.4 Testing

Testing the link is the same for the 1 and 3 jumper method. The difference comes in the calculation of the budget. This calculation is detailed at the end of this section.

- Having referenced the LSPD using jumper method 1 or 3 and under no circumstances removed the connections from the LSPD.
- Plug lead A into the light source meter connector labelled 'Output'
- Plug lead A into one end of the fibre link to be tested
- Plug lead B into the power meter connector labelled 'Input'
- Plug lead B into the remaining end of the fibre link to be tested

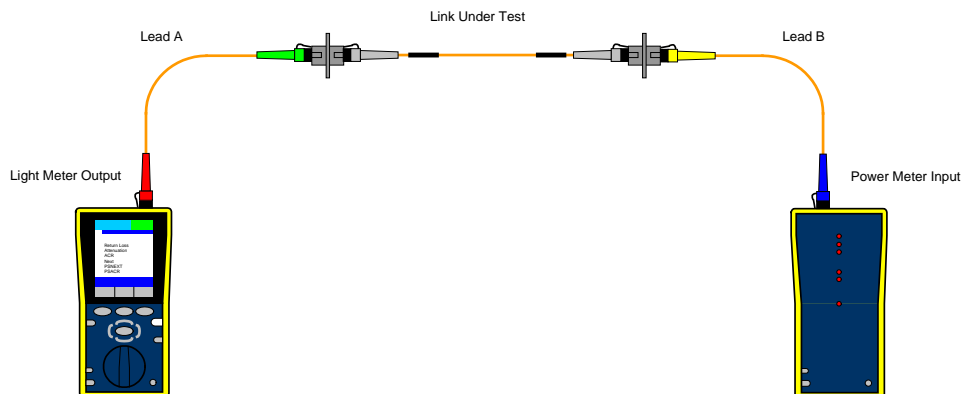

- Test and record the link at 1330 and 1550nm
- Repeat the process for the other direction unless the test equipment allows Bi-Directional testing in which case the 2nd leg of the duplex link is tested by swapping the input and output fibres connected to the link.

I.5 Testing Parameters – 1 Jumper Method

For tests that have used the 1 jumper method referencing the following parameters apply for 1330 and 1550nm.

Attenuation criteria for mated plugs, as defined by EN 14763

Mated Insertion Loss	Multimode Fibres	
	Reference Plug	Unreferenced Plug
Reference Plug	0.2dB	0.5dB
Unreferenced Plug	0.5dB	0.75dB

Attenuation criteria for cable, as defined by EN 14763

Insertion Loss	OS2 Fibre Cable per km	
	1310nm	1550nm
OS2	1.0dB	1.0dB

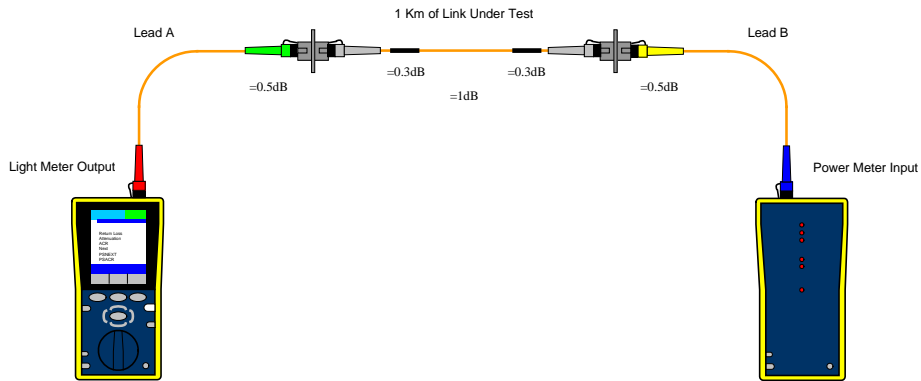

Where the link consists of two connectors the loss budget = $0.5 + 0.5 + 0.3 + 0.3 + 1.0 = 2.6\text{dB}$ for 1330 and 1550nm.

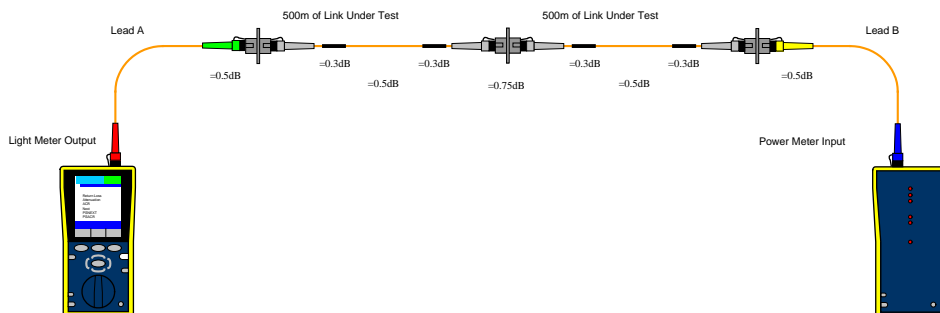

Where the link consists of three connectors the loss budget = $0.5 + 0.75 + 0.5 + 0.3 + 0.3 + 0.3 + 0.3 + 1 = 3.95\text{dB}$ for 1330 and 1550nm.

Any subsequent connectors in the link would be calculated as 0.75dB loss as they are unreferenced to unreferenced connections.

I.6 Testing Parameters – 3 Jumper Method

For tests that have used the 3 jumper method referencing the following parameters apply for 1330 and 1550nm.

Attenuation criteria for mated plugs, as defined by EN 14763

Mated Insertion Loss	Multimode Fibres	
	Reference Plug	Unreferenced Plug
Reference Plug	0.2dB	0.5dB
Unreferenced Plug	0.5dB	0.75dB

Attenuation criteria for cable, as defined by EN 14763

Insertion Loss	OS2 Fibre Cable per km	
	1310nm	1550nm
OS2	1.0dB	1.0dB

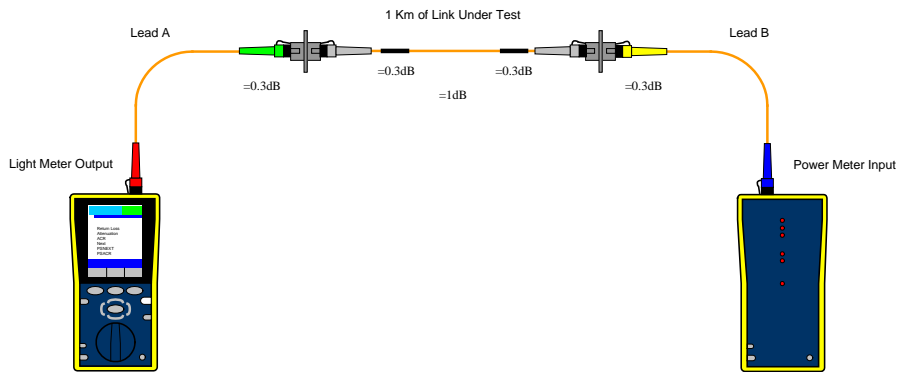

Where the link consists of two connectors the loss budget = $0.3 + 0.3 + 0.3 + 0.3 + 1.0 = 2.2\text{dB}$

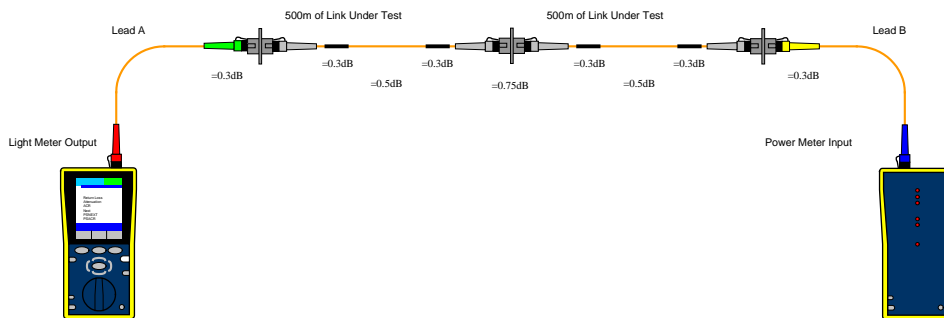

Where the link consists of three connectors the loss budget = $0.3 + 0.75 + 0.3 + 0.3 + 0.3 + 0.3 + 0.3 + 1 = 3.55\text{dB}$

Any subsequent connectors in the link would be calculated as 0.75dB loss as they are unreferenced to unreferenced connections.

Appendix J – External Ducting for Telecommunication Cables

J.1 Ducting Capacity

1. Each duct shall not be filled beyond the specified fill rates shown in NEC Code 2008:
 - 1 off cable/sub duct $\leq 53\%$
 - 2 off cables/sub ducts $\leq 31\%$
 - 3 off cables/sub ducts $\leq 40\%$
2. When installing three or more cables/sub ducts avoid ratios of duct internal diameter to cable sub duct external diameter of 2.8 to 3.1
 - Example 1 - for a duct of 110/94 avoid cable/sub duct external diameters of 32 to 36mm
 - Example 2 - for a duct of 65/50 avoid cable/sub duct external diameters of 16 to 18mm

J.2 Sub Duct Sizing

1. Cables to be pulled into sub ducts shall be of a ratio of ≤ 0.67 for Sub duct ID to Cable OD

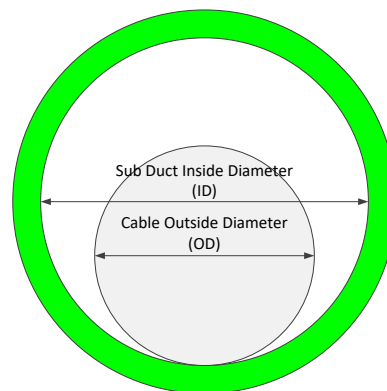

Diameter Ratio = Sub Duct ID/Cable OD
The ratio must be ≤ 0.67

2. The standard sizes for sub ducts for CommScope loose tube fibre cables are:

CommScope Loose Tube Fibre Cables			
Number of Cores	Fibre Cable OD (mm)	Sub Duct Min. ID (mm)	Sub duct size OD/ID (mm)
4 to 12	6.4	9.55	16/10
16	7.5	11.19	16/12
24 to 48	11.5	17.16	25/20

- All three sized sub ducts will not fall within the 32 to 36mm for a 110/94mm ducting system

J.3 Ducting and Sub Ducting Construction and Colour

- All ducts shall be:
 - Compliant to BS EN 50086-1 and BS EN 50086-2-4
 - BS EN 60529 – IP47 rated
 - Twin wall construction
 - Straight sections – no coiled ducting to be used
 - Shall be 100mm internal diameter
 - All ducts to be manufactured from HDPE
 - Smooth bore internally
 - To be green in colour
- All sub ducts shall be:
 - Compliant to BS EN 50086-1 and BS EN 50086-2-4
 - BS EN 60529 – IP47 rated
 - Single wall construction
 - Low friction permanent internal coating
 - All ducts to be manufactured from HDPE
 - Smooth bore internally
 - To be green in colour

J.4 Building Entrance New Builds

1. In new builds the external ducts shall enter from under the building
2. Slow radius 90° preformed bends shall be used with a radius of no less than 600mm
3. The slow radius bend shall be fitted with spigots that can, and shall be sealed with solvent cement
4. The duct shall enter the building at a height of between 350 and 450mm below ground level
5. The duct shall finish 25mm above the finished floor level
6. The duct shall be ≤50mm from the external wall
7. All ducts to be green in colour

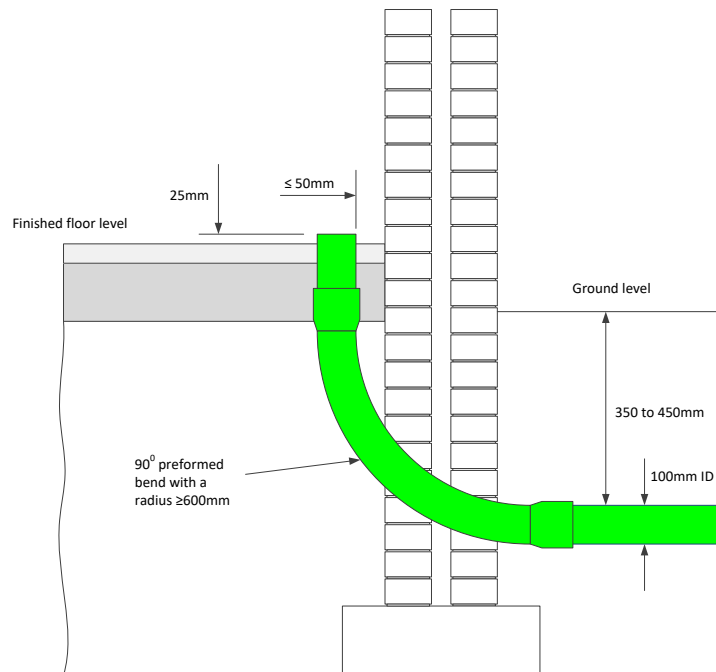

J.5 Building Entrance Existing Builds

1. In existing buildings that require a new building entrance the external ducts shall enter from under the building
2. An aperture will be made in the building fabric with core drilling rigs or other none vibration methods

3. The aperture shall be cut at 45° and the drilling rig shall be anchored and set to this angle. It is not acceptable to core drill using hand held machines
4. The aperture shall allow for a 25mm gap around the duct to be installed
5. Slow radius 45° preformed bends shall be used with a radius of no less than 600mm
6. The slow radius bend shall be fitted with spigots that can, and shall be sealed with solvent cement
7. The duct shall enter the building at a height of between 350 and 450mm below ground level
8. The duct shall finish 25mm above the finished floor level
9. The duct shall be between 50 and 100mm from the external wall
10. The 25mm gap around the duct shall be sealed with a bitumastic compound to a depth of no less than 300mm
11. All ducts to be green in colour

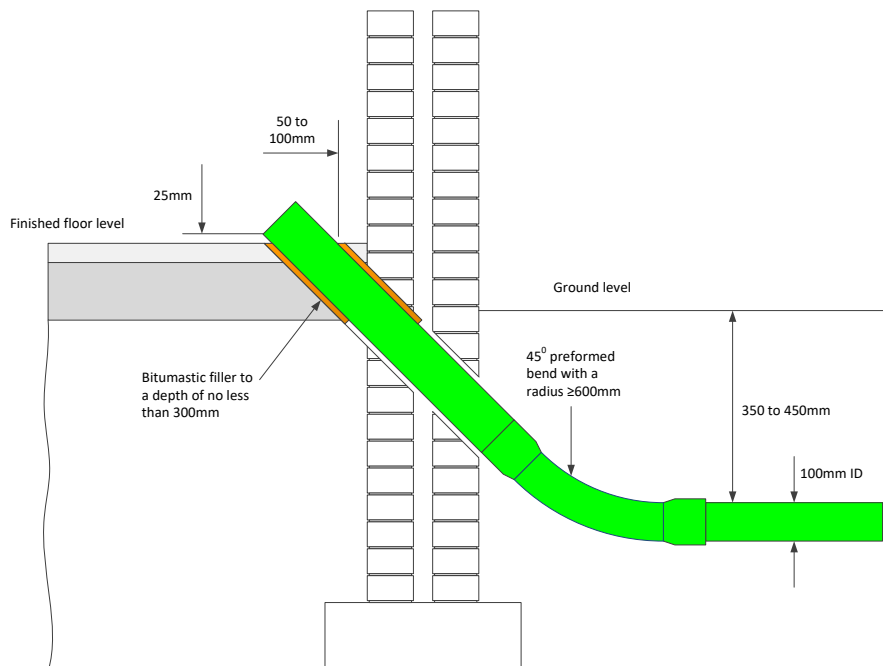

J.6 Building Entrance Basement for New Builds

1. In new builds where there is a basement level the external ducts shall enter from the side of the building
2. The duct shall enter the building at a height of between 350 and 450mm below ground level

3. The duct shall enter the building at a height of between 600 and 1800mm above the finished floor level
4. The duct shall finish 25mm clear of the finished wall
5. All ducts to be green in colour

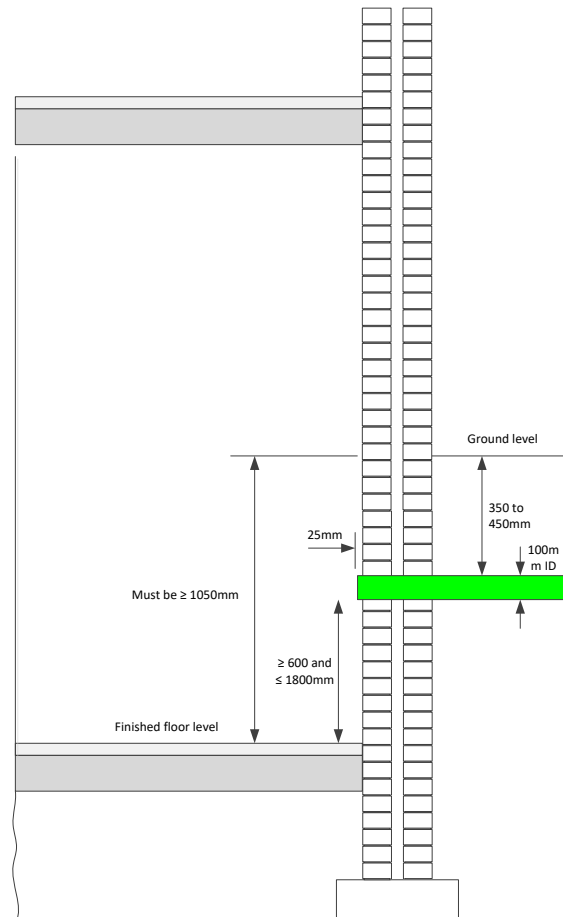

J.7 Building Entrance Basement for Existing Builds

1. In new builds where there is a basement level the external ducts shall enter from the side of the building
2. An aperture will be made in the building fabric with core drilling rigs or other none vibration methods
3. The aperture shall be cut at 90° to the wall and the drilling rig shall be anchored and set to this angle. It is not acceptable to core drill using hand held machines
4. The aperture shall allow for a 25mm gap around the duct to be installed
5. The duct shall enter the building at a height of between 350 and 450mm below ground level

6. The duct shall enter the building at a height of between 600 and 1800mm above the finished floor level
7. The duct shall finish 25mm clear of the finished wall
8. All ducts to be green in colour

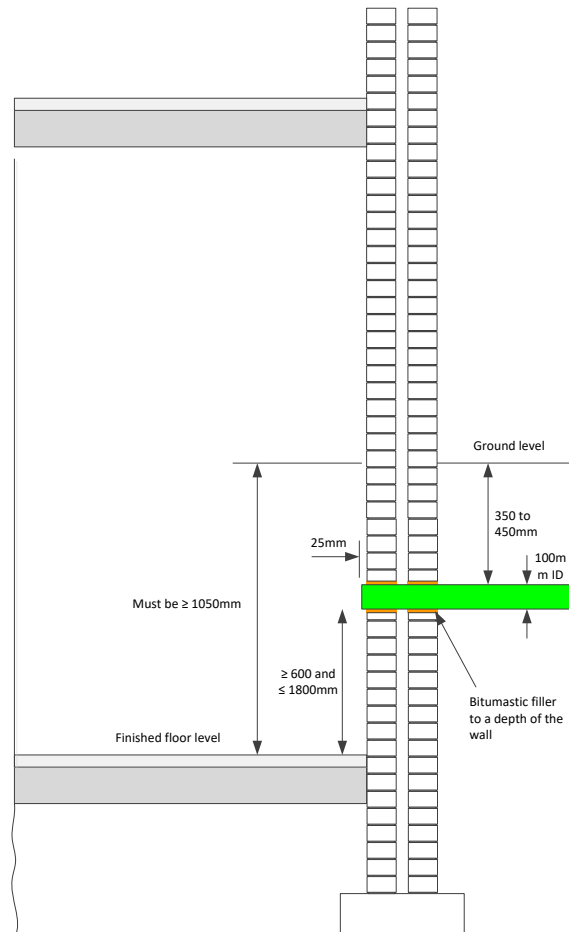

J.8 Building Entrance Where Access Pits Can Flood into a Building

1. A suitable sized mechanical duct plug shall be fitted to the building entry duct system
2. The mechanical duct plug shall be sized to cater for multiple sub ducts
3. The maximum number of sub ducts that the mechanical duct plug can cater for shall be installed on day 1
4. The sub ducts shall be tied to the access pit furniture above the maximum flood level
5. Blank duct plugs shall be fitted at both ends of all unused sub ducts

6. Suitable sized mechanical sub duct plugs shall be fitted at both ends of a sub duct that has a fibre cable(s) installed. This may be required to cater for multiple fibre cables

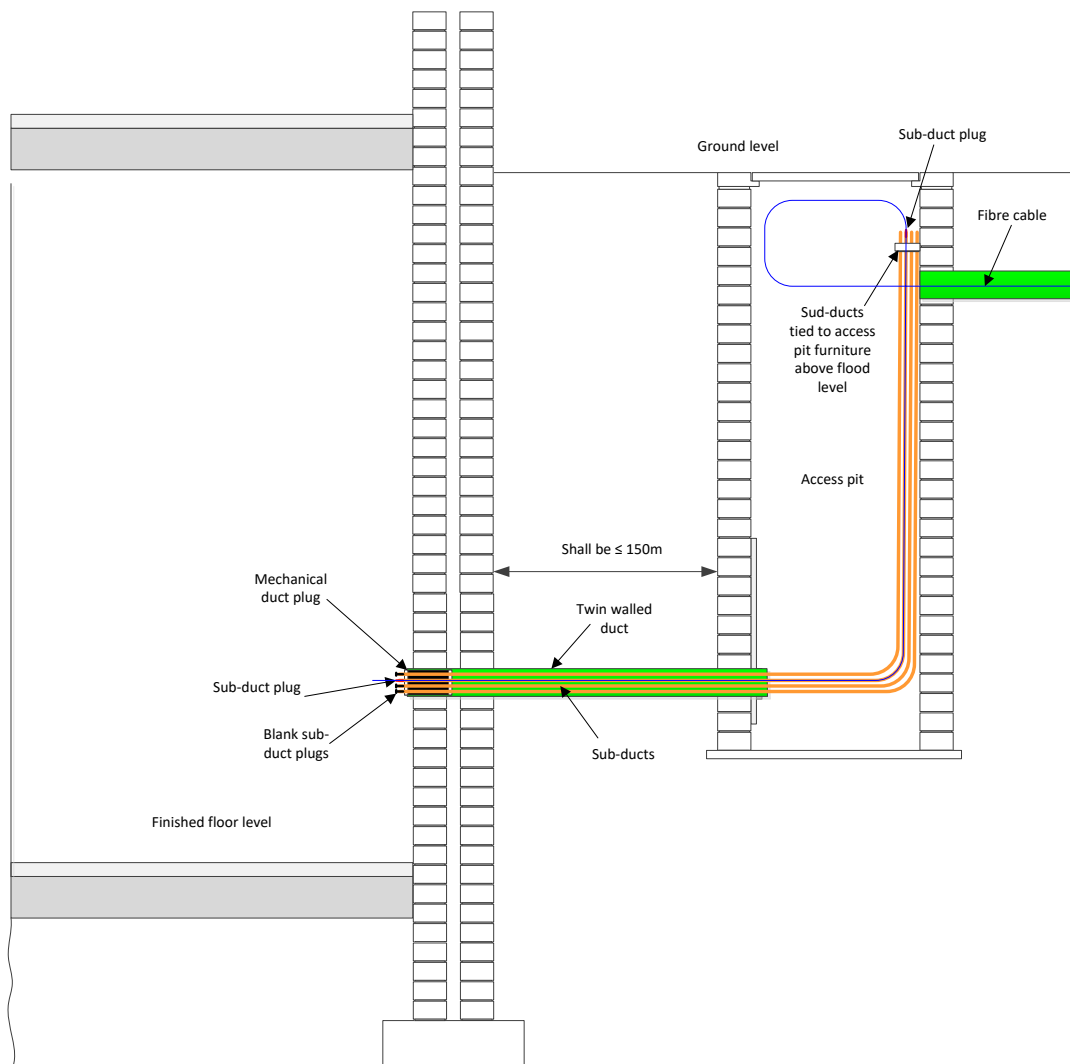

J.9 Ducting Laying

1. The Installer is responsible for the planning, routing and excavation of the ducting
2. IT services will have the final say regarding the proposed route and positioning of chambers and building entries
3. The Installer shall seek and gain clearances from IT Services before any excavation work commences
4. The Installer is responsible for any repairs required to services that are damaged during the works, unless previously identified as damaged

5. Straight sections of ducts shall be secure to each other with the correct solvent cement for the socket and spigot ends or couplers
6. Ducts shall be laid in as straight a line as possible
7. Duct organizers shall be used to prevent undulations. One to be fitted either side of a joint and at 1m intervals along the length of a duct run
8. The order of preference for duct positioning is
 - Unmade surface
 - Verge
 - Footway
 - Carriageway

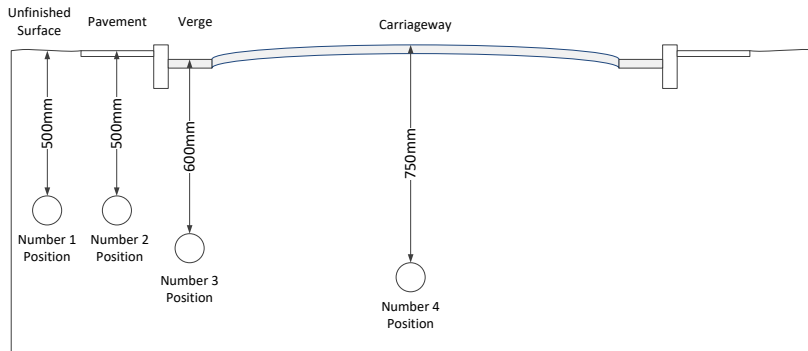

9. Recommended duct formations are

No. of Ducts	Formation	
2	1 row of 2 columns	○ ○
4	2 rows of 2 columns	○ ○ ○ ○
6	2 rows of 3 columns	○ ○ ○ ○ ○ ○
8	2 rows of 4 columns	○ ○ ○ ○ ○ ○ ○ ○

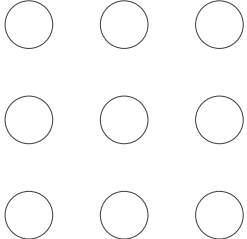
9	3 rows of 3 columns	
---	---------------------	--

10. The ducting shall be greater than or equal to 600mm from other services that run parallel
11. The ducting shall be greater than or equal to 150mm from other services that cross the ducting path

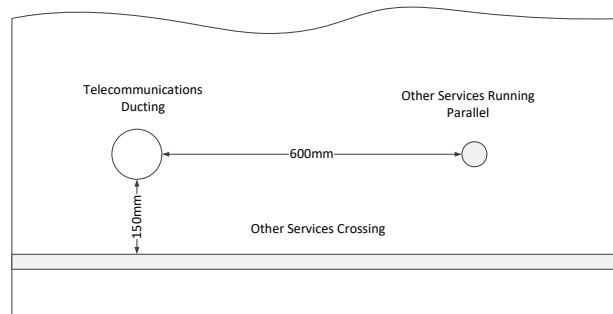

J.10 Ducting Depth

1. Depth of ducting for the different surface finishes are:

Environment	Depth (mm)
Pavement or Grass	500
Verge	600
Urban Roads	750

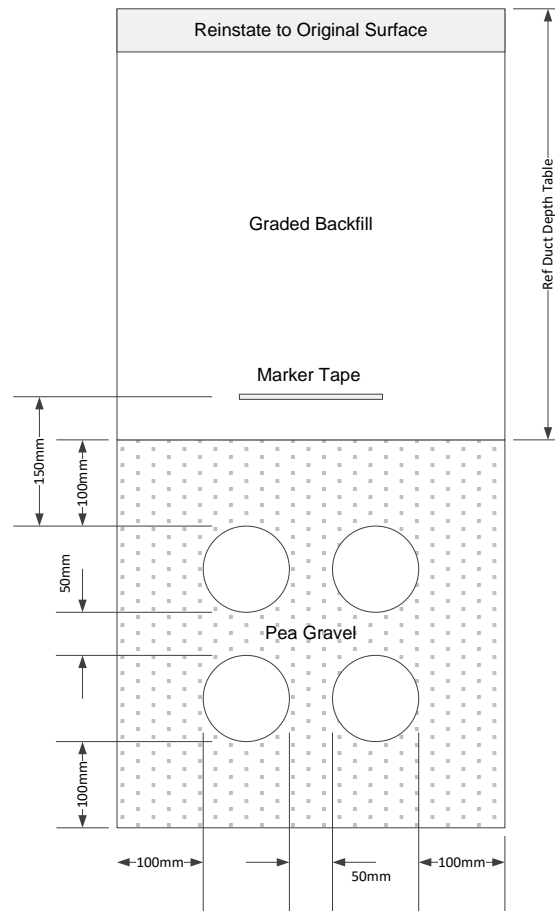

J.11 Duct Route Deviation

1. Where possible ducts shall follow a straight route
2. Access pits shall be installed where the route deviates more than 1:30 horizontally or 1:60 vertically
3. Preformed bends of 90° and 45° are only permissible at building entry points and there cannot be more than 1 preformed bend in any one run
4. Long slow curves are permitted but shall exceed 50m in radius
5. Access pits shall be positioned at no more than 150m apart
6. For every 2m rise in between access pits the duct run shall be halved

J.12 Roding and Roping

1. Ducts that require roding may be undertaken with continuous or 3m section rods
2. The rod ends shall be protected with leader and follower devices to prevent damage to existing cables

3. Only one draw rope may be installed into one duct at a time
4. Draw ropes that have been used to draw in a new cable shall be replaced with a new rope
5. Draw ropes shall be tied off onto the access pit furniture in a tidy manner
6. Draw rope lengths may be spliced together but it is not acceptable to joint using knots
7. Draw ropes shall be made of polypropylene or other none biodegradable plastic
8. Draw ropes shall have a minimum draw strength of 550kg

J.13 Marker Tape

1. Fibre
 - None biodegradable plastic coated aluminium marker tape
 - 150mm above the top duct
 - Central to the duct trench
 - 150mm in width
 - Yellow in colour
 - Marked at 1200mm centres with bold contract lettering 'FIBER OPTIC CABLE BELOW'
2. Copper
 - None biodegradable plastic marker tape
 - 150mm above the top duct
 - Central to the duct trench
 - 150mm in width
 - Yellow in colour
 - Marked at 1200mm centres with bold contract lettering 'TELECOMMUNICATIONS CABLE BELOW'

J.14 Duct Seals

1. Where ducts and sub ducts are being installed the ends shall be sealed with a blank duct plug to prevent the ingress of dust and water
 - These shall be installed at both ends of a duct run during none working hours or working hours when it is raining
2. Where ducts and sub ducts enter an access pit and are left empty a duct plug shall be installed
3. Where ducts enter a building or access pit a multi aperture duct plug shall be used. The duct plug shall be of a split design to allow removal without the cutting of cables or sub ducts
 - The multi aperture duct shall have sealing plugs fitted to the correct aperture size for the sub duct or cable to be sealed against the ingress of gas and water
 - Empty apertures shall be fitted with hole plugs to seal against the ingress of gas and water
 - Sub ducts with cables installed shall be sealed with a simplex duct plug against the ingress of gas and water

J.15 Sub Duct

1. Traditional fibre cables shall be installed within sub ducts
2. The sub duct shall be the correct size for the fibre cable
3. The sub duct run shall be continuous
4. Sub ducts shall not be tied to access pit furniture but shall pass through the pit in a straight a line as possible
5. Sub ducts shall not be coiled within access pits
6. Sub duct sections shall be jointed a threaded connection and sealed with a collapsible cold seal or with compression connectors
7. Where a sub duct passes through an access pit in a straight direction the sub duct may be pulled through in one continuous pull or be jointed as detailed above
8. Where a sub duct passes through a chamber at an angle of 45^o or more the sub duct shall be cut at 100 to 200mm within entering the access pit – to facilitate labelling
9. All open sub ducts with no cables installed shall be sealed with a blank duct plug against the ingress of water and gas
10. All sub ducts with cables pulled into them shall be sealed with a simplex duct plug against the ingress of water and gas

J.16 Access Pits

1. Materials for the access pits are
 - Bricks – Engineering bricks to Class B (BS 6100)
 - Mortar – 3:1 mix of sand to cement
 - Cement – EN197-1:2000 BS12 ordinary mix
2. The pit dimensions shall be a minimum of 1310(l) x 610(w)
3. The access pit shall be constructed on a floor slab of dimensions 150mm in depth and overhanging the access pit by 200mm on all sides
4. The depth of the access pit shall be ≥ 850 mm
5. A sump hole of dimensions 200(w) x 200(l) x 200(d) shall be cast in the floor slab
6. Ducts entering an access pit shall
 - Not be within 150mm of any corner
 - Be ≥ 100 mm from the floor slab – from the bottom of the duct
 - Enter at the required depth – section 9. Duct Depth
 - Finish flush with the access pit wall
 - Be sealed to the access pit wall with bitumastic material
7. Where the depth of chambers exceeds 700 mm below the finished surface of the adjacent ground or carriageway, manhole steps complying with BS EN 13101 shall be built in, as specified in BS EN 1917. Steps should be located at the end remote from any side entry ducts bolts to be tied into one side wall to support the ironwork
8. Minimum of two off wall brackets at a spacing of 700mm apart on the longest wall side. Brackets shall extend from 100mm from the floor slab to 100mm from the cover frame
9. Two off cable bearer brackets to be fitted at each depth of ducting to enter the access pit i.e. if there are ducts entering at 600mm and 750mm there shall be two off brackets at 600mm and two off brackets at 750mm
10. Pulling eyes of a diameter of 22mm to be installed 50mm below each duct or column of ducts. The pulling eye shall have a 10,000 pulling strength
11. Cover frame set squarely on the access pit on a bed of mortar. The frame shall be securely pinned to the wall structure on all side

12. A cover(s) to BS EN 124 (latest revision)
13. Electrical cables exceeding ELV shall not share the same ducting or access pits as telecommunication cables
14. Access pits shall be positioned to provide a safe working area for maintenance and pulling in new cables
15. Where ducts pass beneath roads access pits shall be positioned at each side of the road crossing
16. Where there is known future requirement for ducts, poke outs shall be installed that run 0.5m to 1m from the access pit

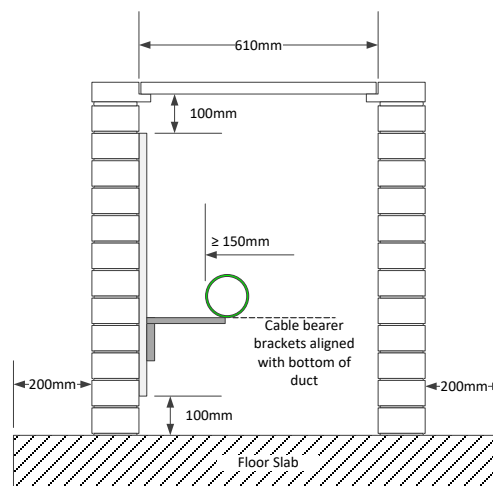
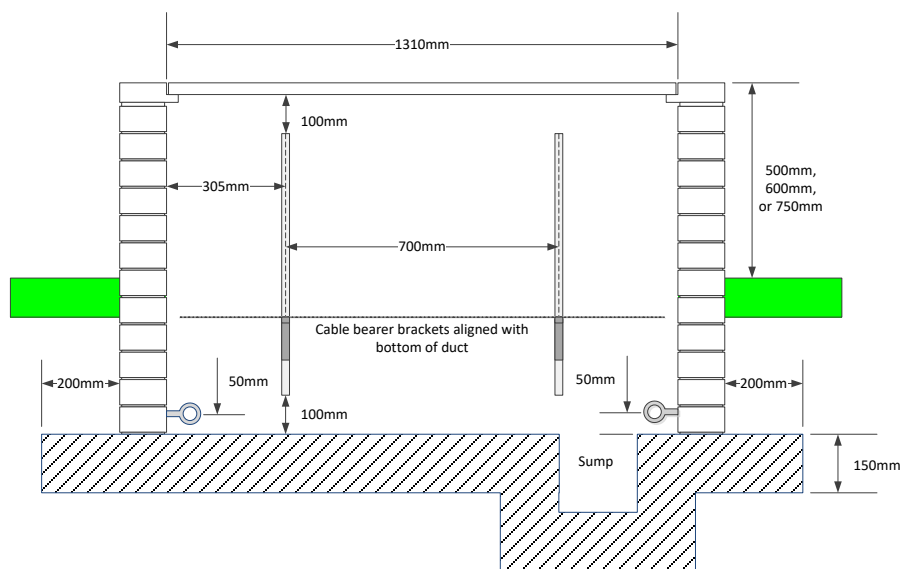

J.17 Access Pit, Duct and Sub Duct Labelling

1. All ducts and sub ducts shall be labelled at each access pit and building entry/exit

2. The label shall be engraved on a plastic tags
3. Plastic engraved tags shall be black writing on a yellow background
4. There shall be apertures at each end of the tag that can accommodate cable ties
5. The tag shall be secured to the sub duct with two off external cable ties
6. Each bank of ducts shall be labelled at all chamber entry/exit points and building entry points. The label shall identify which building or chamber the bank of ducts is connect to. The individual duct labels shall correspond at each end and not read left to right

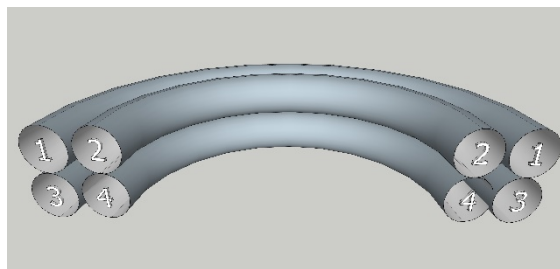

Correct labelling of ducts

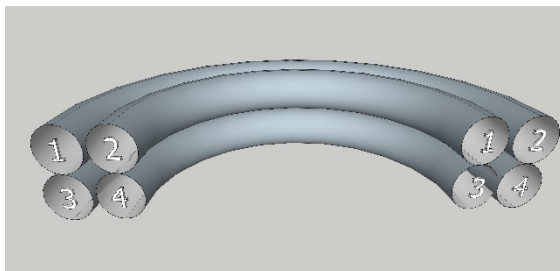

Incorrect labelling of ducts

7. To facilitate operations and administration, all jointing chambers and covers should be clearly labelled.
8. The labels should identify the jointing chamber as a telecommunications facility
9. The labelling scheme should be consistent throughout the system of chambers and each chamber should have a unique identifier

J.18 Duct Testing

1. All ducts shall be tested prior to the installation of sub ducts or cables

2. A mandrel of length ≥ 250 mm and a diameter of 90% of the internal diameter of the duct shall be pulled through the entire length of the duct
3. The mandrel shall have a rope attached to both ends to allow the mandrel to be withdrawn in the event of a blockage
4. If the mandrel is pulled through with debris attached a brush of length ≥ 200 mm and a diameter of 110% of the internal diameter of the duct shall be drawn through in the same manner as the mandrel
5. Once the duct is clear of debris and a mandrel can be drawn through without obstruction a draw rope shall be installed

J.19 Rodent Protection

1. At the duct entries into chambers, all spare space shall be filled with stainless steel wire wool over a duct length of ≥ 100 mm from the end of the duct.

J.20 Duct Sealing to Building Fabric

1. For above ground building entries
 - The lead-in ducts that will be contained within the wall/floor shall be cleaned thoroughly with methylated spirit or isopropyl alcohol
 - Treated all round the circumference for a minimum length of 300mm with suitable solvent weld
 - Before the solvent weld dries approved bitumastic compound applied all around the circumference for a minimum length of 300mm. The bitumastic material shall finish 50mm beyond the finished surface level
 - The remaining 50mm shall be filled with a resin mortar flush to existing surfaces
2. For below ground building entries, the installer shall agree how the integrity of the waterproofing to the building will be maintained with the University Estates Faculty team leader for the building concerned.